



Site layout planning for daylight and sunlight

A guide to good practice

Paul J Littlefair, Stephanie King, Gareth Howlett, Cosmin Ticleanu, and Adam Longfield
Building Technology Group



Acknowledgements

This report was produced following an extensive period of consultation with architects, planning officers, consultants, professional institutions, and government officials. Special thanks to Joe Lynes and John Basing, who helped to formulate some of the original guidance here, and to Dr Peter Defoe, who contributed to the section on rights to light.

The contributions of all concerned are gratefully acknowledged.

BR 209 2022 Edition
BR 209
ISBN 978-1-84806-483-6
© S&P Global 2022

First published 1991
Second edition 2011
Third edition 2022

BRE is the UK's leading centre of expertise on the built environment, construction, energy use in buildings, fire prevention and control, and risk management. BRE Global and BRE Limited are part of the BRE Group, a world-leading research, consultancy, training, testing, and certification organisation, delivering sustainability and innovation across the built environment and beyond. The BRE Group is wholly owned by the BRE Trust, a registered charity aiming to advance knowledge, innovation and communication in all matters concerning the built environment for the benefit of all. All BRE Group profits are passed to the BRE Trust to promote its charitable objectives.

BRE is committed to providing impartial and authoritative information on all aspects of the built environment. Whilst BRE makes every effort to ensure the accuracy and quality of the information when it is published, BRE does not accept any responsibility or liability for the accuracy, completeness, legality, or reliability of the information contained in this publication. Further, no warranties, guarantees and/or representations of any kind, expressed or implied, are given as to the nature, standard, accuracy or otherwise of the information provided in this publication nor to the suitability or otherwise of the information to any particular circumstance. BRE takes no responsibility for the subsequent use of this information by any person or organisation.

The publisher accepts no responsibility for the persistence or accuracy of URLs referred to in this publication, and does not guarantee that any content on such websites is, or will remain, accurate or appropriate.

Contents

Summary	4
How to use the guide	5
Glossary	6
1. Introduction	7
2. Light from the sky	8
2.1 New development	8
2.2 Existing buildings	14
2.3 Adjoining development land	18
3. Sunlighting	21
3.1 New development	21
3.2 Existing buildings	24
3.3 Gardens and open spaces	26
4. Solar energy	30
4.1 Introduction	30
4.2 Passive solar energy	30
4.3 Photovoltaics	33
4.4 Active solar thermal	34
4.5 General considerations	34
5. Other issues	37
5.1 Introduction	37
5.2 View	37
5.3 Privacy	38
5.4 Security	38
5.5 Access	39
5.6 Enclosure	39
5.7 Microclimate	40
5.8 Solar dazzle	41
5.9 Solar convergence	42
6. References	43
7. Bibliography	44
Appendix A: Indicators to calculate access to skylight, sunlight, and solar radiation	46
Appendix B: Waldram diagram to calculate vertical sky component	68
Appendix D: Plotting the no sky line	79
Appendix E: Rights to light	83
Appendix F: Setting alternative target values for skylight and sunlight access	85
Appendix G: Trees and hedges	88
Appendix H: Environmental impact assessment	92

Summary

This guide gives advice on site layout planning to achieve good sunlighting and daylighting, both within buildings and in the open spaces between them. It is intended to be used in conjunction with the interior daylight recommendations for new buildings in the British Standard *Daylight in buildings*, BS EN 17037. It contains guidance on site layout to provide good natural lighting within a new development; safeguarding of daylight and sunlight within existing buildings nearby; and the protection of daylighting of adjoining land for future development. A special section deals with loss of solar radiation for solar panels and for passive solar buildings that use the sun as a source of heating energy. Guidance is also given on the sunlighting of gardens and amenity areas. Issues like privacy, enclosure, microclimate, road layout, and security are briefly reviewed. The appendices contain methods to quantify access to sunlight and daylight within a layout.

This report is a comprehensive revision of the 2011 edition of *Site layout planning for daylight and sunlight: a guide to good practice*. It is purely advisory and the numerical target values within it may be varied to meet the needs of the development and its location. Appendix F explains how this can be done in a logical way, while retaining consistency with the British Standard recommendations on interior daylighting.



How to use the guide

Before using this guide, read the introduction (section 1) which sets out the scope and nature of the guidance.

Summary of content

Terms and definitions

A glossary of terms and definitions used within the guide is on page 6.

Designing for good daylighting and sunlighting within a new development

Refer to Section 2.1 in Section 2 *Light from the sky*, section 3.1 in Section 3 *Sunlighting*, and Appendix C. Section 4 explains how to plan for winter solar heat gain. If there is a conflict with other requirements, Section 5 gives advice.

Protecting the daylighting and sunlighting of existing buildings

See Sections 2.2 and 3.2. Appendix E explains rights to light.

Daylighting of land adjoining a development

This is covered in Section 2.3. Section 3.3 deals with sunlight in gardens and other open spaces between buildings.

Loss of radiation to solar panels

This is covered in section 4.

Trees and hedges

Appendix G gives guidance on trees.

Environmental impact assessment

Appendix H explains how to apply the guidance on environmental impact assessment.

The other appendices contain calculation methods and data to help assess the daylighting and sunlighting within a site layout.

Glossary

Illuminance	A measure of the amount of light falling on a surface, usually measured in lux.
Target illuminance (E_T)	Illuminance from daylight that should be achieved for at least half of annual daylight hours across a specified fraction of the reference plane in a daylit space.
Minimum target illuminance (E_{TM})	Illuminance from daylight that should be achieved for at least half of annual daylight hours across 95% of the reference plane in spaces with vertical and/or inclined daylight apertures.
Daylight factor (D)	Ratio of total daylight illuminance at a reference point on the working plane within a space to outdoor illuminance on a horizontal plane due to an unobstructed CIE standard overcast sky. Thus a 1% D would mean that the indoor illuminance at that point in the space would be one hundredth the outdoor unobstructed horizontal illuminance.
Target daylight factor	Daylight factor value equivalent to the target illuminance to be exceeded for more than half of annual daylight hours over a specified fraction of the reference plane within a daylit space.
Minimum target daylight factor	Daylight factor value equivalent to the minimum target illuminance to be exceeded for more than half of annual daylight hours over 95% of the reference plane within spaces with vertical and/or inclined daylight apertures.
CIE standard overcast sky	<p>A completely overcast sky for which the ratio of its luminance L_γ at an angle of elevation γ above the horizontal to the luminance L_z at the zenith is given by:</p> $L_\gamma = L_z \frac{(1 + 2 \sin \gamma)}{3}$ <p>A CIE standard overcast sky is darkest at the horizon and brightest at the zenith (vertically overhead).</p>
Daylight, natural light	Combined skylight and sunlight.
No sky line	The outline on the working plane of the area from which no sky can be seen.
Obstruction angle	The angular altitude of the top of an obstruction above the horizontal, measured from a reference point in a vertical plane in a section perpendicular to the vertical plane.
Annual probable sunlight hours	The long-term average of the total number of hours during a year in which direct sunlight reaches the unobstructed ground (when clouds are taken into account).
Sky factor	This is used in rights to light calculations. It is the ratio of the parts of illuminance at a point on a given plane that would be received directly through unglazed openings from a sky of uniform luminance, to the illuminance on a horizontal plane due to an unobstructed hemisphere of this sky. The sky factor does not include reflected light, either from outdoor or indoor surfaces.
Vertical sky component (VSC)	This is a measure of the amount of light reaching a window. It is the ratio of that part of illuminance, at a point on a given vertical plane, that is received directly from a CIE standard overcast sky, to illuminance on a horizontal plane due to an unobstructed hemisphere of this sky. Usually the 'given vertical plane' is the outside of a window wall. The VSC does not include reflected light, either from the ground or from other buildings.
Reference plane or working plane	Horizontal, vertical, or inclined plane in which a visual task lies. Normally the working plane may be taken to be horizontal, 0.85 m above the floor in houses and factories, 0.7 m above the floor in offices.
Assessment grid	Grid of calculation points on the reference plane that is used to calculate daylight factor or illuminance from daylight. Also known as calculation grid.
(Solar) irradiance	A measure of the amount of solar radiation (including infrared and ultraviolet radiation as well as daylight) falling on a surface. Usually measured in Watts per square metre.

1. Introduction

1.1 People expect good natural lighting in their homes and in a wide range of non-domestic buildings. Daylight makes an interior look more attractive and interesting as well as providing light to work or read by. Access to skylight and sunlight helps make a building energy efficient; effective daylighting will reduce the need for electric light, while winter solar gain can meet some of the heating requirements.

1.2 The quality and quantity of natural light in an interior depend on two main factors. The design of the interior environment is important: the size and position of windows, the depth and shape of rooms, and the colours of internal surfaces. But the design of the external environment also plays a major role: e.g. if obstructing buildings are so tall that they make adequate daylighting impossible, or if they block sunlight for much of the year.

1.3 This guide gives advice on site layout planning to achieve good daylighting and sunlighting, within buildings and in the open spaces between them. It is intended to be used in conjunction with the interior daylighting recommendations in BS EN 17037 *Daylight in buildings*^[1], and in the CIBSE publication *LG 10 Daylighting – a guide for designers*^[2]. This guide complements them by providing advice on the planning of the external environment. If these guidelines on site layout are followed, along with the window design recommendations in BS EN 17037 and *LG 10 Daylighting – a guide for designers*, there is potential to achieve good daylighting in new buildings, and retain it in existing buildings nearby.

1.4 Other sections in the guide give guidance on site layout for solar energy and on the sunlighting of gardens and amenity areas, and briefly review issues like privacy, enclosure, microclimate, road layout, and security. The appendices contain methods to quantify access to sunlight and daylight within a layout.

1.5 This guide supersedes the 2011 edition, which is now withdrawn. However, the main aim is the same: to help ensure good conditions in the local environment considered broadly, with enough sunlight and daylight on or between the buildings for good interior and exterior conditions.

1.6 The guide is intended for building designers and their clients, consultants, and planning officials. The advice given here is not mandatory and the guide should not be seen as an instrument of planning policy; its aim is to help rather than constrain the designer. Although it gives numerical guidelines, these should be interpreted flexibly since natural lighting is only one of many factors in site layout design (see Section 5). In special circumstances the developer or planning authority may wish to use different target values. For example, in a historic city centre, or in an area with modern high-rise buildings, a higher degree of obstruction may be unavoidable if new developments are to match the height and proportions of existing buildings. Alternatively, where natural light is of special importance, less obstruction and hence more sunlight and daylight may be deemed necessary. The calculation methods in Appendices A and B are entirely flexible in this respect. Appendix F gives advice on how to develop a consistent set of target values for skylight under such circumstances.

1.7 The guidance here is intended for use in the United Kingdom and in the Republic of Ireland, though recommendations in the Irish Standard IS EN 17037 may vary from those in BS EN 17037. Many of the principles outlined will apply to other temperate climates. More specific guidance for other locations and climate types is given in BRE Report *Environmental site layout planning*^[3].

2. Light from the sky

2.1 New development

2.1.1 The quantity and quality of daylight inside a room will be impaired if obstructing buildings are large in relation to their distance away. The distribution of light in the room will be affected as well as the total amount received. The guidelines below may be used for dwellings and any non-domestic buildings where daylight is required.

2.1.2 Obstruction can be quantified in a number of ways. The amount of daylight entering a room with a wide obstruction opposite is proportional to the angle of visible sky θ (Greek theta), measured from the centre of the window (Figure 1). This assumes no light comes around the sides of the obstruction. The maximum θ for a vertical window is 90° if there are no obstructions.

2.1.3 θ is related to obstruction angle (the angle the obstruction makes from the centre of the window, measured from the horizontal). If we do not count light blocked by the top of the window, θ equals 90° minus the obstruction angle. So the taller and nearer the obstruction, the less light is received.

2.1.4 θ can be hard to estimate if the obstruction is not continuous, or if it projects from the window wall (e.g. an extension to a house at one side of the window). Good daylighting may still be achievable with a tall obstruction, provided it is not continuous and is narrow enough to allow adequate daylight around its sides. The amount of skylight falling on a vertical wall or window can be quantified as the vertical sky component (VSC) (Figure 2). This is the ratio of the direct sky illuminance falling on the vertical wall at a reference point (usually the centre of the window), to the simultaneous horizontal illuminance under an unobstructed sky. The standard Commission Internationale d'Eclairage – International Commission on Illumination (CIE) overcast sky is used, and the ratio is usually expressed as a percentage. The maximum value is almost 40% for a completely unobstructed vertical wall. Table C1 in Appendix C gives values of θ equivalent to different VSCs.

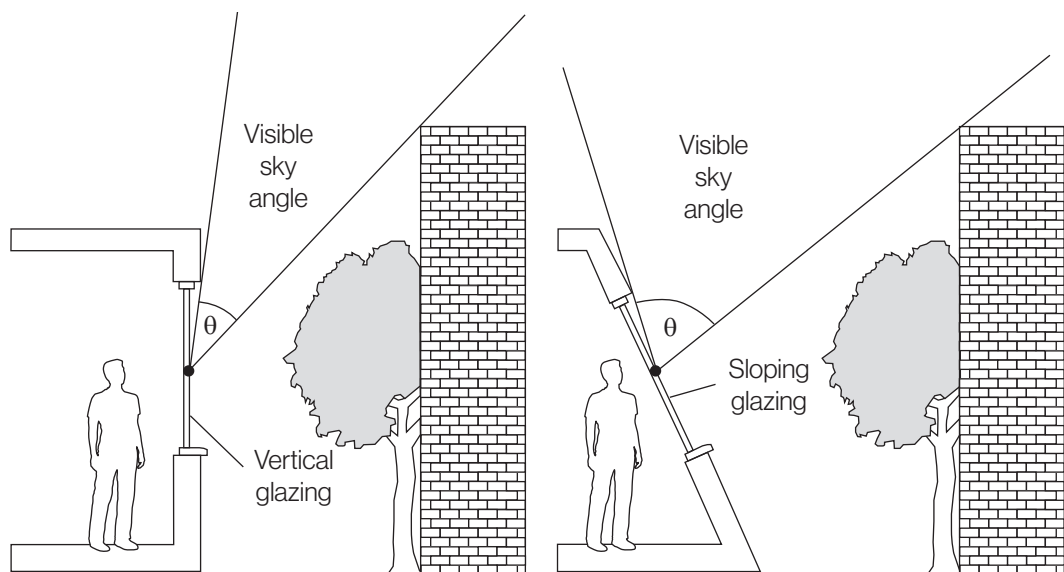

Figure 1: θ is the angle of visible sky measured from the centre of the window, in a vertical plane (section) perpendicular to that of the window

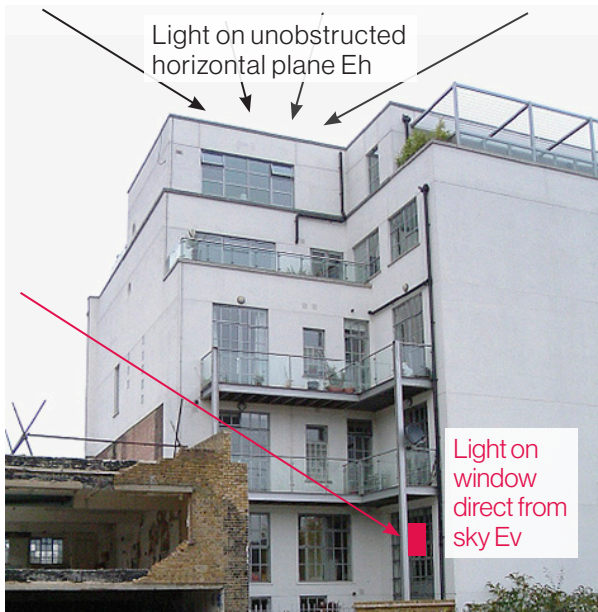

Figure 2: The vertical sky component is the illuminance on the outside of the window, divided by the illuminance on an unobstructed roof, under overcast sky conditions. Reflected light is not included.



Figure 3: In Georgian streets the small spacing-to-height ratio is compensated for by tall windows. Note how window head height increases for the lower floors which are more heavily obstructed.

2.1.5 VSCs may be calculated using the skylight indicator (Figure A1 in Appendix A) or Waldram diagram (Figure B1 in Appendix B), or by using computer software. Note that all obstructing buildings will have an effect, not just those on the site being developed. Appendix G explains the effect of trees and when to include them in the calculation.

2.1.6 The amount of daylight a room needs depends on what it is being used for. But roughly speaking, if θ is:

- greater than 65° (obstruction angle less than 25° or VSC at least 27%) conventional window design will usually give reasonable results.
- between 45° and 65° (obstruction angle between 25° and 45° , VSC between 15% and 27%) special measures (larger windows, changes to room layout) are usually needed to provide adequate daylight.
- between 25° and 45° (obstruction angle between 45° and 65° , VSC between 5% and 15%) it is very difficult to provide adequate daylight unless very large windows are used.
- less than 25° (obstruction angle greater than 65° , VSC less than 5%) it is often impossible to achieve reasonable daylight, even if the whole window wall is glazed.

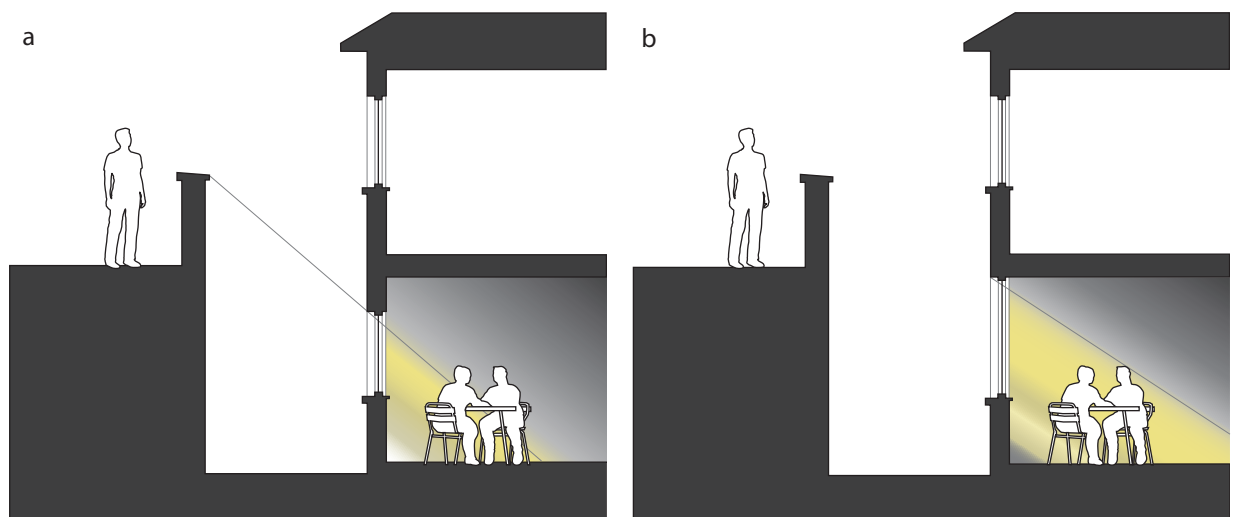

Figure 4: Daylight penetration in a basement (a) is improved by a raised window head (b)

2.1.7 Where space in a layout is restricted, interior daylighting may be improved in a number of ways. An obvious one is to increase window sizes; the best way to do this is to raise the window head height because this will improve both the amount of daylight entering and its distribution within the room (Figure 3). Raising the window head can be particularly effective for basement windows (Figure 4).

2.1.8 Detailed recommendations for daylight in new buildings are given in BS EN 17037 *Daylight in Buildings*^[1]; for schools in England, alternative recommendations are given by the Department for Education^[4]. Daylight provision in new rooms may be checked using either of the methods in BS EN 17037 *Daylight in Buildings*^[1]: direct prediction of illuminance levels using hourly climate data, or the use of the daylight factor (D) (Figure 5). Both are measures of the overall amount of daylight in a space. The daylight factor (D) addresses daylight provision as a ratio of unobstructed external illuminance under overcast sky conditions.

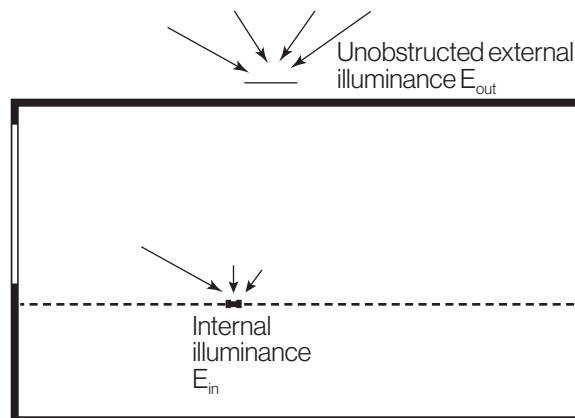

Figure 5: Definition of daylight factor D. Under standard overcast conditions: $D = E_{in} / E_{out} \times 100\%$

2.1.9 Appendix C summarises the recommendations in BS EN 17037 and explains how the relevant quantities can be calculated. The illuminance recommendations are based around the illuminances that would be met or exceeded over half of the room, over half of daylight hours over the year. The alternative recommendation is based on calculating the daylight factor that would be exceeded over half of the room (this is not the same as the average daylight factor used in the previous standard, BS8206 Part 2^[5]). The recommended daylight factor values are location specific; a set of targets is provided for each of 10 locations in the United Kingdom. The target values for the reference location at the nearest latitude to the development location should be used.

2.1.9 Appendix C summarises the recommendations in BS EN 17037 and explains how the relevant quantities can be calculated. The illuminance recommendations are based around the illuminances that would be met or exceeded over half of the room, over half of daylight hours over the year. The alternative recommendation is based on calculating the daylight factor that would be exceeded over half of the room (this is not the same as the average daylight factor used in the previous standard, BS8206 Part 2^[5]). The recommended daylight factor values are location specific; a set of targets is provided for each of 10 locations in the United Kingdom. The target values for the reference location at the nearest latitude to the development location should be used.

2.1.10 BS EN 17037 gives a range of recommendations for 'high', 'medium', and 'minimum' daylight provision. The National Annex A of BS EN 17037 also gives minimum values for housing, in living rooms, kitchens, and bedrooms. These are minimum recommended values for locations where a predominantly daylight appearance is not achievable; for example in basement rooms or with significant external obstructions (perhaps in a dense urban area or with tall trees outside), or for existing buildings being converted into dwellings. Achieving higher daylight factor values (see Appendix C) will give improved daylight provision. This would be particularly appropriate in housing for the elderly, because they require more light and are more likely to be at home during the day.

2.1.11 However, interiors with very high daylight levels (for example where a daylight illuminance of 500 lux is exceeded over half the room for more than half of the daylight hours) sometimes have problems with summertime overheating or excessive heat loss in winter. Guidance is given in *Reducing overheating: a designers guide*^[6] and *Overheating in new homes*^[7]

2.1.12 Appendix C gives guidance on how to calculate illuminances and daylight factors. They depend on room reflectances, so having light-coloured room surfaces will increase them, provided these can be kept clean. In calculations, realistic surface reflectances should be used to take account of maintenance and the lower reflectance of doors and furniture. Appendix C gives recommended values; the reflectances used in the calculation should be stated, and the finishes should be specified in the design of the building. The calculations should include potential future obstructions if other buildings are planned to be constructed nearby. Appendix G explains how to take into account obstructions caused by trees and hedges.

2.1.13 At the very early stages in design, room layouts and window locations may be undecided. In this situation, one approach is to calculate the VSC at a series of points on each main face of the building 1.6 m above the ground (or lowest storey base) and no more than 5 m apart. Where the VSC is found to change rapidly along a façade it is worthwhile, if possible, to site windows where most daylight is available.



Figure 6: Windows near internal corners, such as the corners of courtyards, are usually heavily obstructed



Figure 7: A tunnel effect can occur if a window has projecting wings on both sides of it. In this development in South London (architects Broadway Malyan), the windows have been increased in size to compensate.

This situation often occurs at the internal corners of courtyards or L-shaped blocks. If windows are sited close to these corners they will result in poor levels of daylight as well as potential lack of privacy (Figure 6). Other problem locations include basement windows or those next to a big extension or projection, especially if there are extensions either side of the window (Figure 7).

2.1.14 Living rooms and kitchens need more daylight than bedrooms, so where there is a choice it is best to site the living room or kitchen away from obstructions. Dual-storey maisonette-type apartments may be planned with the main living rooms on the upper storey and the bedrooms on the lower floor for this reason. Areas without a special requirement for daylight, like bathrooms, stairwells, garages, and storage areas, can occupy the most obstructed areas such as internal corners of buildings. In mixed use developments commercial uses may occupy the less well daylighted areas, allowing residential parts to have better access to light.

2.1.15 Non-daylit internal kitchens should be avoided wherever possible, especially if the kitchen is used as a dining area too. Daylight levels in kitchen areas should be checked. If the layout means that a small internal kitchen is inevitable, it should be directly linked to a well daylighted room. Further guidance for assessment of this situation is given in Appendix C.

2.1.16 Improving external surface reflectances will also help. Light-coloured building materials (Figure 8) and paving slabs on the ground may be used. However, maintenance of such surfaces should be planned in order to stop them discolouring. Often the benefits may not be as great as envisaged, partly because of ageing of materials and partly for geometrical reasons. The vertical surface of an obstructing building will only receive light from half of the sky. If it is itself obstructed, less skylight will be received and reflected. Thus, even if it is light coloured its brightness can never approach that of unobstructed sky. White paints are not perfect reflectors and direct some of the reflected light back upwards. Windows in the obstructing wall act as absorbers, reducing its effective reflectance. Over time, dirt and debris can collect on the wall, darkening it still further, unless it is regularly cleaned and repainted (Figure 9). Any planting, though pleasant to look at, also absorbs light. Appendix C gives recommendations for typical and maximum reflectances of exterior surfaces. The reflectances used in the calculation should be stated.

2.1.17 Balconies and overhangs significantly reduce the light entering windows below them (Figure 10). This is a particular problem if there are large obstructions opposite; with the combined effect of the overhang and the obstruction, it may be impossible to see the sky from inside, and hence to receive any direct



Figure 8: A white finish to external walls, as in this North London development (architects Sheppard Robson), can increase reflected light. However, windows will tend to reduce the overall effective reflectance.



Figure 9: White walls require regular maintenance or their reflectance will deteriorate, as shown here

skylight or sunlight at all. Although a balcony is often a pleasant amenity and can provide solar shading to windows below it, in a heavily obstructed situation the balcony may be less valued because it may lack privacy and receive little sun.

2.1.18 There are various techniques to minimise the effect of balconies and overhangs such as access decks. Glazing in the balcony, and making the resulting enclosed area part of the living room, gives a private internal space that can still receive daylight and sunlight. This is beneficial in obstructed ground floor rooms; otherwise, ground floor occupants are obstructed by the balcony above without having a balcony area of their own. Depending on the layout of the building, sometimes the façade can be stepped back to allow rooftop access or terraced gardens, without creating an overhang to the windows below (Figure 11).

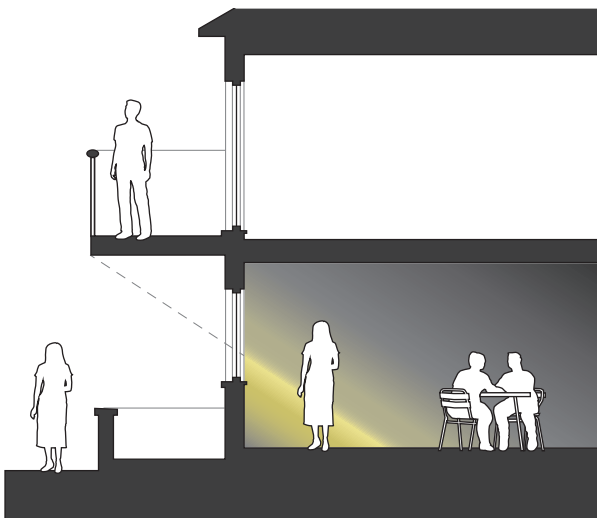

Figure 10: Balconies and projecting access ways can restrict daylight to rooms lit by windows below them

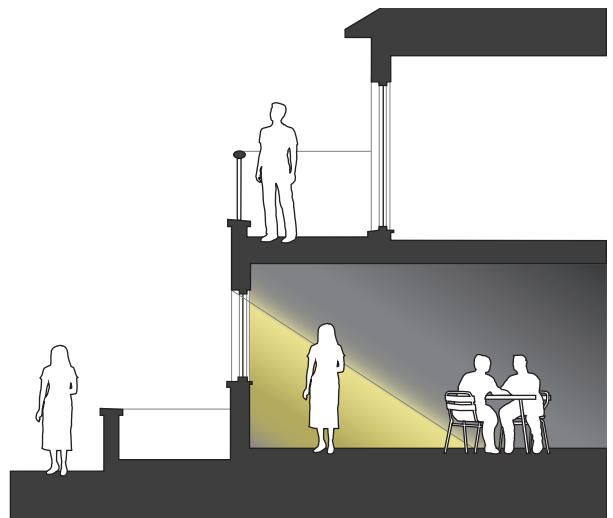

Figure 11: Section showing stepped back rooftop access ways. This gives improved daylight compared to a conventional section (see Figure 10).

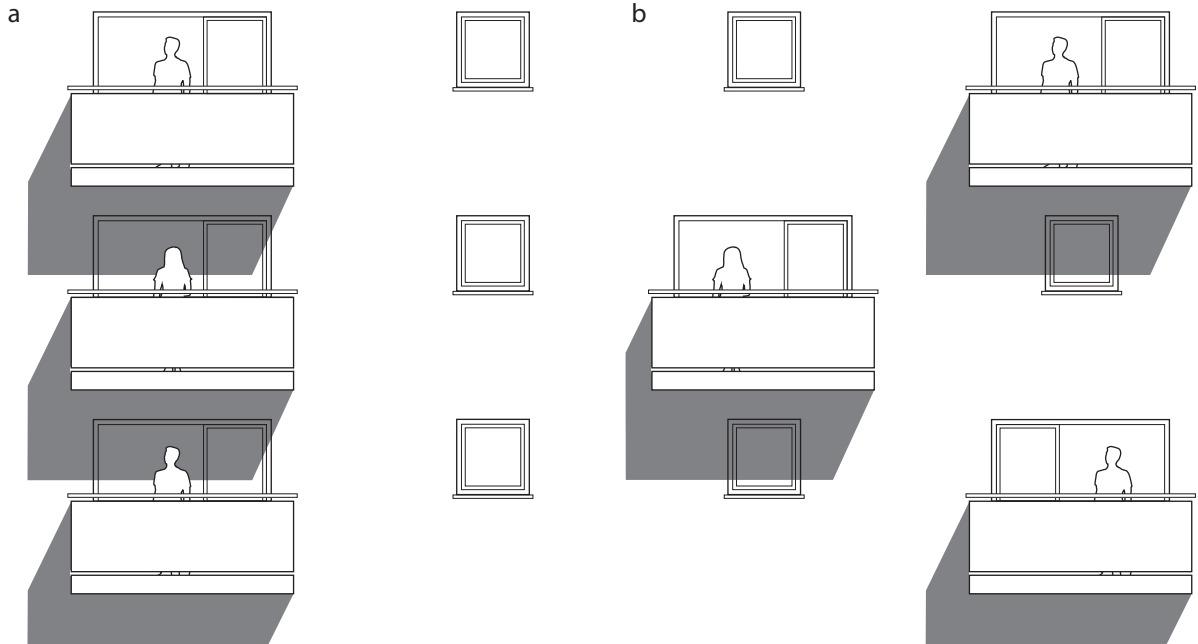

Figure 12: In a conventional layout (a) the balcony above each living room reduces the daylight it receives. Staggered balconies (elevation b) give improved daylight and sunlight to living rooms.

2.1.19 Alternatively, balconies may be staggered so that a living room has its own balcony, but not one directly above it (Figures 12 and 13). Bathrooms or – in less obstructed situations – bedrooms could be sited underneath the balcony. Balconies may be arranged so that they are only partly above the windows to a room so that room can receive more daylight and sunlight from other, less obstructed windows. Having some unobstructed windows is particularly important if a neighbouring site is likely to be redeveloped in the future. A room that is heavily obstructed by its own design and reliant on daylight over low-rise neighbouring buildings may lose most of its light in the event of future changes to those buildings. One way to check this would be to carry out an additional calculation with notional future developments in place.

2.1.20 Finally, one important way to plan for good interior daylight is to reduce building depth (window wall to window wall). Even on a totally unobstructed site a very deep room cannot be properly daylight. The presence of obstructions makes it even more difficult for a deep room to have enough light. Dual-aspect rooms generally have better daylight distribution as well as the potential for more sunlight (see section 3.1).



Figure 13: This North London development (architects CZWG) has staggered balconies to minimise obstruction to living rooms. Where a balcony is above a living room the obstructed area has been modified to form an unobstructed bay window.

Summary

2.1.21 Obstructions can limit access to light from the sky. This can be checked at an early design stage by measuring or calculating the angle of visible sky θ , angle of obstruction or vertical sky component (VSC) at the centre of the lowest window where daylight is required. If VSC is:

- at least 27% (θ is greater than 65° , obstruction angle less than 25°) conventional window design will usually give reasonable results.
- between 15% and 27% (θ is between 45° and 65° , obstruction angle between 25° and 45°) special measures (larger windows, changes to room layout) are usually needed to provide adequate daylight.
- between 5% and 15% (θ is between 25° and 45° , obstruction angle between 45° and 65°) it is very difficult to provide adequate daylight unless very large windows are used.
- less than 5% (θ less than 25° , obstruction angle more than 65°) it is often impossible to achieve reasonable daylight, even if the whole window wall is glazed.

2.1.22 To check that adequate daylight is provided in new rooms, daylight factor or interior illuminance may be calculated and compared with the recommendations in BS EN 17037 *Daylight in buildings*⁽¹⁾ (see Appendix C).

2.2 Existing buildings

2.2.1 In designing a new development or extension to a building, it is important to safeguard the daylight to nearby buildings. A badly planned development may make adjoining properties gloomy and unattractive.

2.2.2 The guidelines given here are intended for use for rooms in adjoining dwellings where daylight is required, including living rooms, kitchens, and bedrooms. Windows to bathrooms, toilets, storerooms, circulation areas, and garages need not be analysed. The guidelines may also be applied to any existing non-domestic building where the occupants have a reasonable expectation of daylight; this would normally include schools, hospitals, hotels and hostels, small workshops, and some offices.

2.2.3 Note that numerical values given here are purely advisory. Different criteria may be used based on the requirements for daylighting in an area viewed against other site layout constraints. Another important issue is whether the existing building is itself a good neighbour, standing a reasonable distance from the boundary and taking no more than its fair share of light. Appendix F gives further guidance.

2.2.4 Loss of light to existing windows need not be analysed if the distance of each part of the new development from the existing window is three or more times its height above the centre of the existing window. In these cases the loss of light will be small. Thus, if the new development were 10 m tall, and a typical existing ground floor window would be 1.5 m above the ground, the effect on existing buildings more than $3 \times (10 - 1.5) = 25.5$ m away need not be analysed.

2.2.5 If the proposed development is taller or closer than this, a modified form of the procedure adopted for new buildings can be used to find out whether an existing building still receives enough skylight. First, draw a section in a plane perpendicular to each affected main window wall of the existing building (Figure 14). Measure the angle to the horizontal subtended by the new development at the level of the centre of the lowest window. If this angle is less than 25° for the whole of the development then it is unlikely to have a substantial effect on the diffuse skylight enjoyed by the existing building. If, for any part of the new development, this angle is more than 25° , a more detailed check is needed to find the loss of skylight to the existing building. Both the total amount of skylight and its distribution within the building are important.

2.2.6 Any reduction in the total amount of skylight can be calculated by finding the VSC at the centre of each main window. In the case of a floor-to-ceiling window such as a patio door, a point 1.6 m above ground

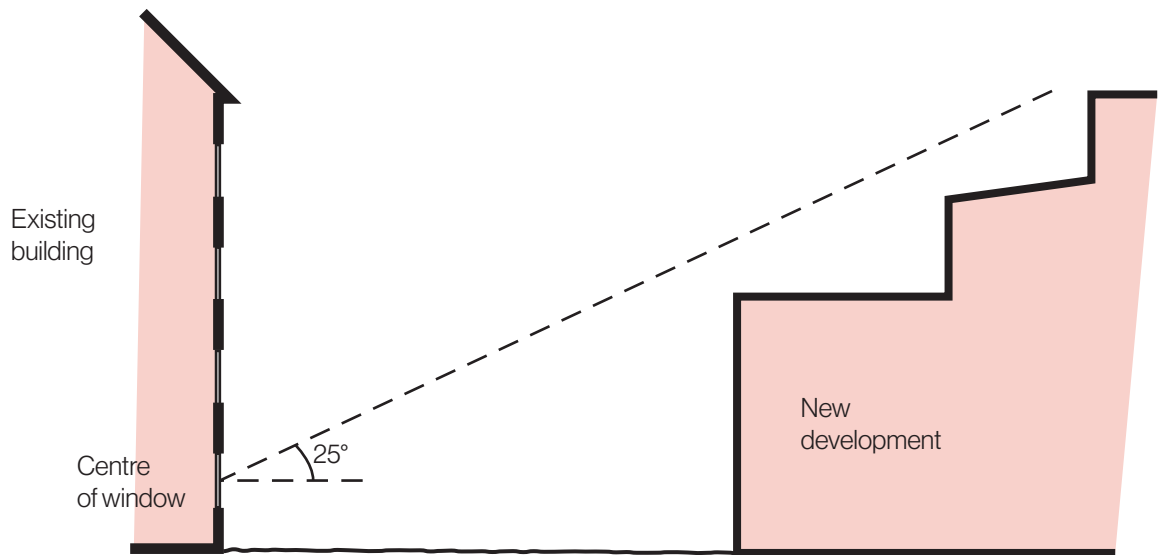

Figure 14: Section in plane perpendicular to the affected window wall

(or balcony level for an upper storey) on the centre line of the window may be used. For a bay window, the centre window facing directly outwards can be taken as the main window. If a room has two or more windows of equal size, the mean of their VSCs may be taken. The reference point is in the external plane of the window wall. Windows to bathrooms, toilets, storerooms, circulation areas, and garages need not be analysed. The VSC can be found by using the skylight indicator (Figure A1 in Appendix A) or Waldram Diagram (Figure B1 in Appendix B), or appropriate computer software.

2.2.7 If this VSC is greater than 27% then enough skylight should still be reaching the window of the existing building. This value of VSC typically supplies enough daylight to a standard room when combined with a window of normal dimensions, with glass area around 10% or more of the floor area. Any reduction below this level should be kept to a minimum. If the VSC, with the new development in place, is both less than 27% and less than 0.80 times its former value, occupants of the existing building will notice the reduction in the amount of skylight. The area lit by the window is likely to appear gloomier, and electric lighting will be needed more of the time. In presenting results, ratios of VSC should be given to at least two decimal places (for example 0.79 or 0.81) or as the equivalent percentage loss (for example 21% or 19%).

2.2.8 If there would be a significant loss of light to the main window but the room also has one or more smaller windows, an overall VSC may be derived by weighting each VSC element in accordance with the proportion of the total glazing area represented by its window. For example, a room has a main window of area 2 m² whose VSC would drop from 24% to 18%, 0.75 times the value before. However, it also has a smaller window, area 1 m², for which the VSC would be unchanged at 30%. The area weighted VSC 'before' would be $(24 \times 2 + 30) / 3 = 26\%$. 'After' it would be $(18 \times 2 + 30) / 3 = 22\%$, 0.85 times the value 'before'. Thus, loss of VSC to the room as a whole would meet the guideline. This method would only be appropriate in situations where the windows light the same areas of the room. It should not be used in situations such as a through lounge more than 5m from window to window, where, for example, a loss of light to the front windows and front portion of the room may not be mitigated by daylight from the rear windows.

2.2.9 For sloping or horizontal rooflights a similar approach can be used, with a horizontal or sloping sky component. If the value with the new development in place is less than 0.80 times the value before, there would be a noticeable reduction in the light entering the rooflight. Horizontal or sloping sky components cannot be calculated using the methods in Appendices A or B; specialist software is required.

2.2.10 Where room layouts are known (for example if they are available on the local authority's planning portal), the impact on the daylighting distribution in the existing building should be found by plotting the no sky line in each of the main rooms. For houses this would include living rooms, dining rooms, and kitchens; bedrooms should also be analysed although they are less important. In non-domestic buildings each

main room where daylight is expected should be investigated. The no sky line divides points on the working plane which can and cannot see the sky. (Figure 15). (In houses the working plane is assumed to be horizontal and 0.85 m high; in offices 0.7 m high; in special interiors like hospital wards and infant school classrooms a different height may be appropriate.) Areas beyond the no sky line, since they receive no direct daylight, usually look dark and gloomy compared with the rest of the room, however bright it is outside. Supplementary electric lighting will be needed if a significant part of the working plane (20% of the room or more) lies beyond the no sky line. Appendix D gives advice on how to plot the no sky line.

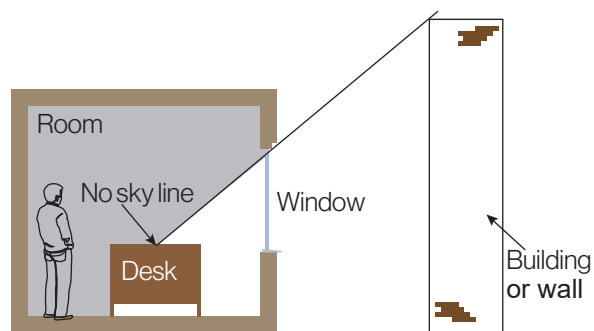

Figure 15: The no sky line divides areas of the working plane which can and cannot receive direct skylight

2.2.11 If, following construction of a new development, the no sky line moves so that the area of the existing room, which does receive direct skylight, is reduced to less than 0.80 times its former value this will be noticeable to the occupants, and more of the room will appear poorly lit. This is also true if the no sky line encroaches on key areas like kitchen sinks and worktops. In presenting results, ratios of lit area should be given to at least two decimal places (for example 0.79 or 0.81) or as the equivalent percentage loss (for example 21% or 19%).

2.2.12 The guidelines above need to be applied sensibly and flexibly. There is little point in designing tiny gaps in the roof lines of new development in order to safeguard no sky lines in existing buildings. If an existing building contains rooms lit from one side only and greater than 5m deep, then a greater movement of the no sky line may be unavoidable.

2.2.13 Existing windows with balconies above them typically receive less daylight. Because the balcony cuts out light from the top part of the sky, even a modest obstruction opposite may result in a large relative impact on the VSC, and on the area receiving direct skylight. One way to demonstrate this would be to carry out an additional calculation of the VSC and area receiving direct skylight, for both the existing and proposed situations, without the balcony in place. For example, if the proposed VSC with the balcony was under 0.80 times the existing value with the balcony, but the same ratio for the values without the balcony was well over 0.8, this would show that the presence of the balcony, rather than the size of the new obstruction, was the main factor in the relative loss of light.

2.2.14 A larger relative reduction in VSC may also be unavoidable if the existing window has projecting wings on one or both sides of it, or is recessed into the building so that it is obstructed on both sides as well as above.

2.2.15 However, as a general rule the aim should be to minimise the impact to the existing property. This is particularly important where successive extensions are planned to the same building. In this case the total impact on skylight due to all the extensions needs to be calculated and compared with the guidance above.

2.2.16 For domestic extensions that adjoin the front or rear of a house, a quick method can be used to assess the diffuse skylight impact on the house next door. It only applies where the nearest side of the extension is perpendicular to the window (Figure 16); it is not valid for windows which directly face the extension, or for buildings opposite. For these cases the guidelines above should be used.

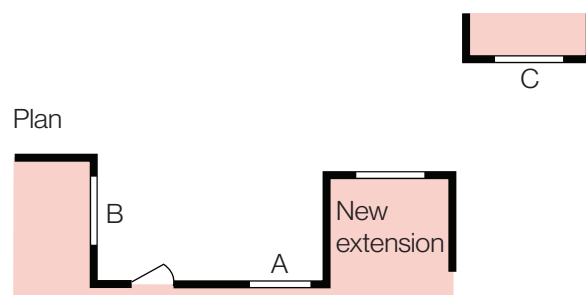

Figure 16: To assess the impact of the new extension, the 45° approach may be used for window A but not for windows B and C which directly face it

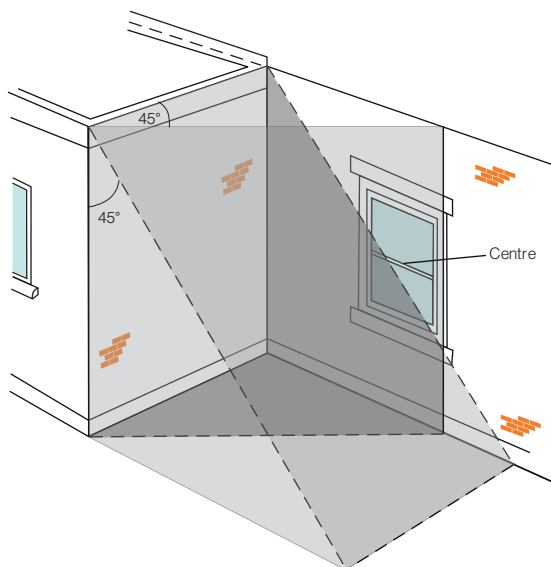

Figure 17: Application of the 45° approach to a domestic extension. A significant amount of light is likely to be blocked if the centre of the window lies within the 45° angle on both plan and elevation. Here the centre of the window lies outside the 45° angle on elevation, so the impact of the extension is likely to be small.

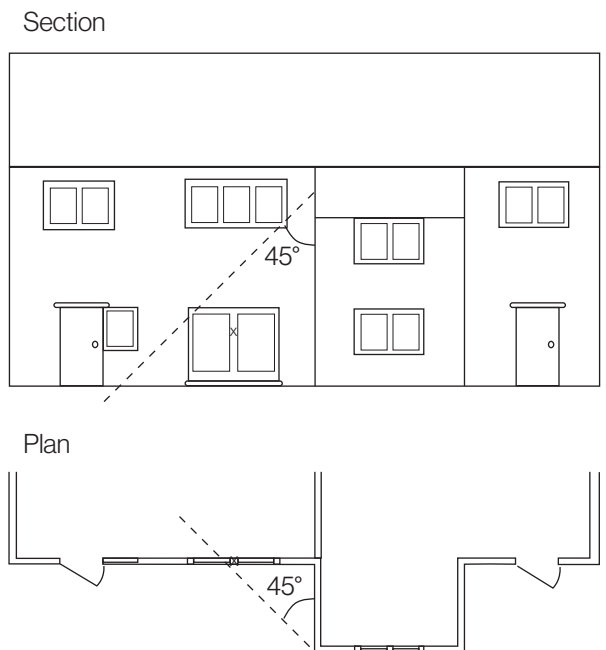

Figure 18: Here the extension has a pitched roof, so a point halfway along the roof slope is used as the start of the 45° line on the elevation. The affected window is a patio door, so a point 1.6 m above the ground has been taken. This point is within the 45° angles on both plan and elevation, so a significant reduction of light is likely.

2.2.17 Figure 17 illustrates the application of the method, the '45° approach'. Take the elevation of the window wall and draw diagonally down at an angle of 45° away from the near top corner of the extension (Figure 17). If the extension has a pitched roof then the top of the extension can be taken as the height of its roof halfway along the slope (Figure 18). Then take the plan and draw diagonally back at an angle of 45° towards the window wall from the end of the extension (note that the section perpendicular to the window is not used here). If the centre of a main window of the next-door property lies on the extension side of both these 45° lines then the extension may well cause a significant reduction in the skylight received by the window. (In the case of a floor-to-ceiling window such as a patio door, a point 1.6 m above the ground on the centre line of the window may be used.)

2.2.18 Like most rules of thumb, this one needs to be interpreted flexibly. For example, if the extension has another extension, or a much larger building, behind it then the daylight from that direction may be blocked anyway. Special care needs to be taken in cases where an extension already exists on the other side of the window, to avoid a 'tunnel effect' (Figure 19). A VSC calculation (see Sections 2.2.5 and 2.2.6) can be used to quantify the loss of light, if required.

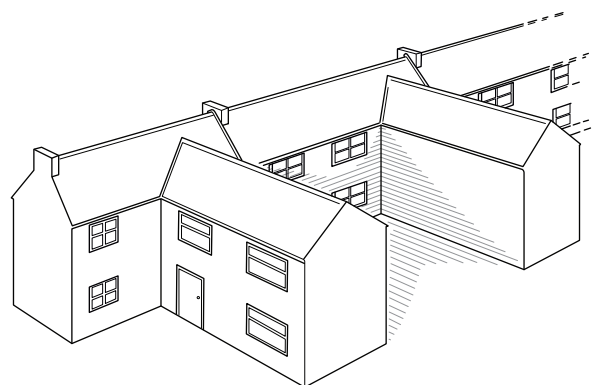

Figure 19: A tunnel effect can occur if a window is obstructed by extensions on both sides

2.2.19 Finally, as with the other guidelines in this section, the 45° approach deals with diffuse skylight only. Additional checks will need to be made for the sunlight which may be blocked (see Section 3.2).

2.2.20 The windows of some existing buildings may also have a right to light^[6] (see Appendix E). None of the guidelines here is intended to replace, or be a means of satisfying, the legal requirements in the law surrounding the right to light. The assessment of loss of light in rights of light cases is carried out in a different way to the methods given in this BRE guide. It should not be assumed that if the guidelines given here are satisfied then a new development will not infringe rights to light, or vice versa. If an existing building does have a right to light, then it would be prudent for the designer of the new development to check that it does not infringe that right.

2.2.21 It is not always apparent whether a right to light exists, but any window in a building older than 20 years should be assumed to have acquired a right under the Prescription Act 1832, in the absence of evidence to the contrary. The advice of a specialist consultant, and possibly a lawyer, may be needed. Appendix E gives further details.

2.2.22 Obstruction of light from the sky is just one of the ways in which a new development can affect existing buildings nearby. The obstruction of sunlight is also important (see Sections 3.2 and 3.3) as are questions of view and privacy (see Section 5).

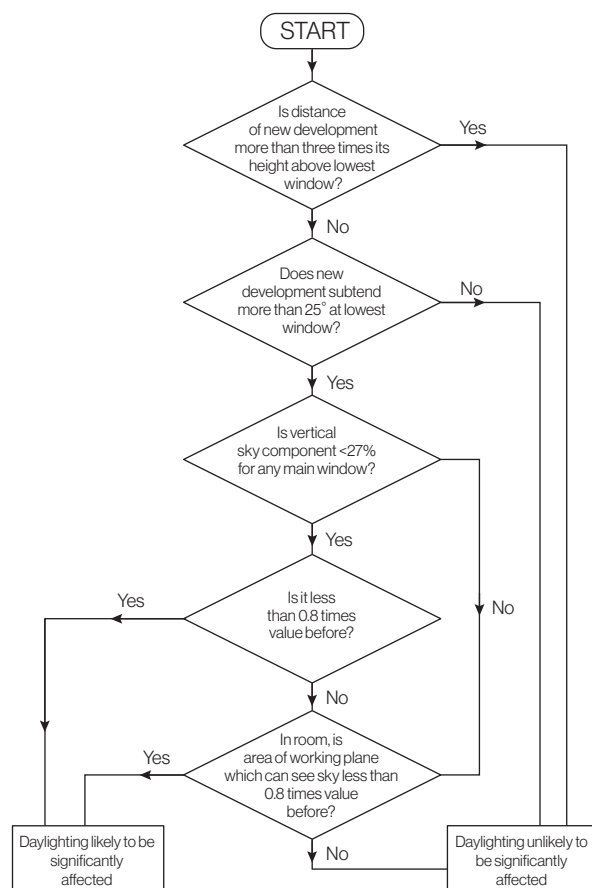

Figure 20: Decision chart: diffuse daylight in existing buildings. This does not include an assessment of rights to light issues, which a developer may need to consider separately.

Summary (Figure 20)

2.2.23 If any part of a new building or extension, measured in a vertical section perpendicular to a main window wall of an existing building, from the centre of the lowest window, subtends an angle of more than 25° to the horizontal, then the diffuse daylighting of the existing building may be adversely affected. This will be the case if either:

- the VSC measured at the centre of an existing main window is less than 27%, and less than 0.80 times its former value
- the area of the working plane in a room which can receive direct skylight is reduced to less than 0.80 times its former value.

2.3 Adjoining development land

2.3.1 From a daylighting standpoint it is possible to reduce the quality of adjoining development land by building too close to the boundary. A well-designed building will stand a reasonable distance back from the boundaries so as to enable future nearby developments to enjoy a similar access to daylight. By doing so it will also keep its own natural light when the adjoining land is developed.

2.3.2 This applies to future non-domestic development as well as housing. However, it does not apply when no main window wall, either of the current new development or of any probable future development on the adjoining site, will face over the boundary. Thus, the guidance below is not applicable for a boundary

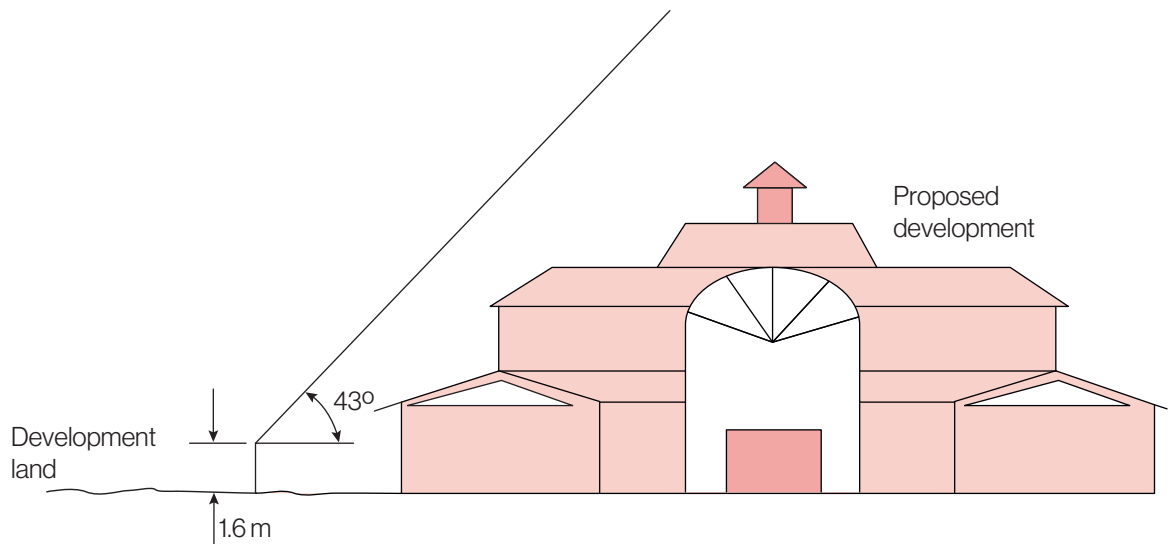

Figure 21: Angular criterion for overshadowing of future development land (on left)

next to a windowless flank wall of a new house where any future housing next door should also present a flank wall without windows; nor need it apply to an industrial estate where new development and any future development is either windowless or solely rooflit.

2.3.3 The diffuse daylight coming over the boundary may be quantified in the following way. As a first check, draw a section in a plane perpendicular to the boundary (Figure 21). If a road separates the two sites then the centre line of the road should be taken. Measure the angle to the horizontal subtended at a point 1.6 metres above the boundary by the proposed new buildings. If this angle is less than 43° then there will normally still be the potential for good daylighting on the adjoining development site (but see Sections 2.3.6 and 2.3.7).

2.3.4 If any of the new buildings is taller than this, enough skylight may still reach the development site provided the building is narrow enough to allow adequate light around its sides. This may be quantified by calculating the VSC (see Section 2.1) at a series of points 1.6 m above the boundary and facing towards the proposed new buildings. Here only obstructions caused by the proposed new buildings need to be taken into account. This contrasts with the calculations for buildings where all obstructions need to be included in the analysis. VSCs may be found using the skylight indicator (Figure A1 in Appendix A) or Waldram Diagram (Figure B1 in Appendix B), or by appropriate computer software.

2.3.5 Overall the adjoining development site should normally retain the potential for good daylighting with appropriate window sizing if every point 1.6 m above the boundary line is within 4 m (measured along the boundary) of a point with a VSC of 17% or more. This corresponds to the value for a continuous obstruction subtending the 43° angle above.

2.3.6 The guidelines above should not be applied too rigidly. A particularly important exception occurs when the two sites are very unequal in size and the proposed new building is larger in scale than the likely future development nearby. This is because the numerical values above are derived by assuming the future development will be exactly the same size as the proposed new building (Figure 22). If the adjoining sites for development are a lot smaller, a better approach is to make a rough prediction of where the nearest window wall of the future development may be; then to carry out the 'new building' analysis in Section 2.1 for this window wall.

2.3.7 The 43° angle should not be used as a form generator, to produce a building that slopes or steps down towards the boundary. Compare Figure 23 with Figure 22 to see how this can result in a higher than anticipated obstruction to daylight. In Figure 23 the proposed building subtends 34° at its mirror image, rather than the maximum of 25° suggested here. In cases of doubt, the best approach is again to carry out a new building analysis for the most likely location of a window wall of a future development.

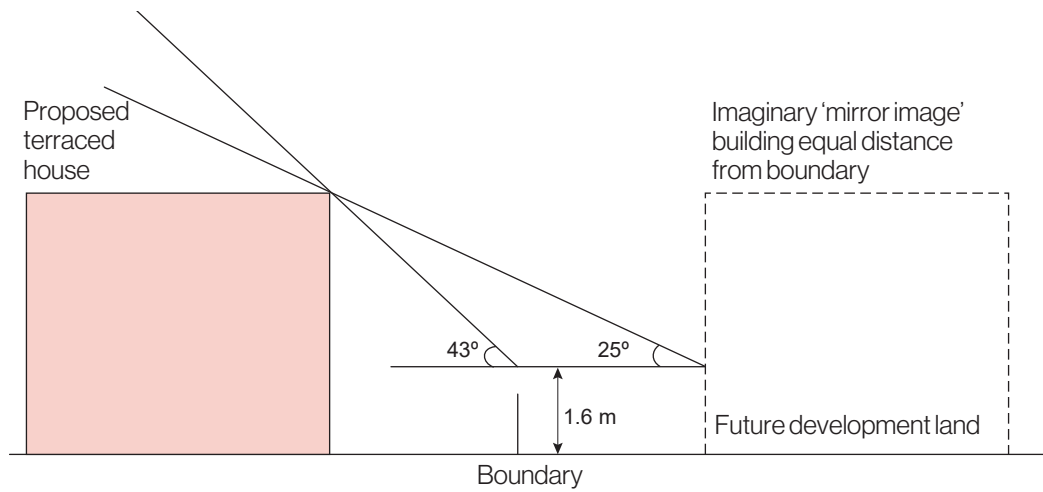

Figure 22: Derivation of an angular boundary criterion to safeguard future development of adjoining land

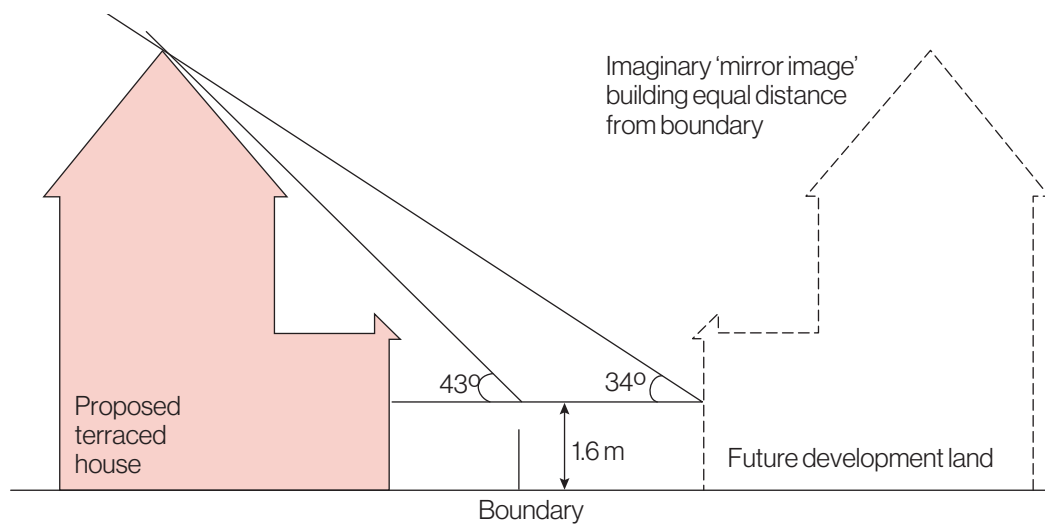

Figure 23: Problems with the boundary criterion can occur when a stepped façade overlooks adjoining land

2.3.8 The numerical values quoted above are purely advisory. Different values may be used depending on the type of development earmarked for the adjoining land. All the calculation methods are flexible in this respect. Table F1 in Appendix F gives the VSCs which correspond to different obstruction angles at the boundary, and relates the boundary values to those for faces of buildings to ensure self consistency.

2.3.9 For simplicity, no numerical guidance is given on sunlighting of land for future development. However, a proposed building or group of buildings can significantly reduce the sunlighting of an adjoining site. If this is likely to be a problem, a good way to assess it is to draw the shadows cast by the new buildings at different times of the year. Section 3.3 gives details.

Summary

2.3.10 In broad general terms (taking into account the exceptions above), a development site next to a proposed new building will retain the potential for good diffuse daylighting provided that on each common boundary:

- no new building, measured in a vertical section perpendicular to the boundary, from a point 1.6 m above ground level, subtends an angle of more than 43° to the horizontal.
- or, if (a) is not satisfied, then all points 1.6 metres above the boundary line are within 4 m (measured along the boundary) of a point which has a VSC (looking towards the new building(s)) of 17% or more.

3. Sunlighting

3.1 New development

3.1.1 People like sunlight. In surveys^[9] around 90% said they appreciated having sunlight in their homes. The sun is seen as providing light and warmth, making rooms look bright and cheerful and also having a therapeutic, health-giving effect.

3.1.2 In housing, the main requirement for sunlight is in living rooms, where it is valued at any time of day but especially in the afternoon. Sunlight is also required in conservatories. It is viewed as less important in bedrooms and in kitchens, where people prefer it in the morning rather than the afternoon.

3.1.3 Sunlight is also valued in non-domestic buildings. However, the requirement for sunlight will vary according to the type of non-domestic building, the aims of the designer and the extent to which the occupants can control their environment. People appreciate sunlight more if they can choose whether to be exposed to it, either by changing their positions in the room or using adjustable shading. Where prolonged access to sunlight is available, shading devices will also be needed to avoid overheating and unwanted glare from the sun. This can apply to housing as well. (Figure 24). BRE Report *Solar shading of buildings*^[10] gives recommendations. Shading provision should be based on the need for it; there is no point in having large overhangs or louvres to windows that receive little or no sun, and they can restrict daylight from entering the room.

3.1.4 In the winter, solar heat gain can be a valuable resource, reducing the need for space heating. Good design can make the most of this. This aspect of sunlight provision is dealt with in Section 4; here we concentrate on the amenity aspects of sunlight.

3.1.5 Site layout is the most important factor affecting the duration of sunlight in buildings. It can be divided into two main issues, orientation and overshadowing.

Orientation

3.1.6 A south-facing window will, in general, receive most sunlight, while a north-facing one will only receive it on a handful of occasions (early morning and late evening in summer). East- and west-facing windows will receive sunlight only at certain times of the day. A dwelling with no main window wall within 90° of due south is likely to be perceived as insufficiently sunlit. This is usually only an issue for flats. Sensitive layout design of flats will attempt to ensure that each individual dwelling has at least one main living room which can receive a reasonable amount of sunlight. In both flats and houses, a sensible approach is to try to match internal room layout with window wall orientation. Where possible, living rooms should face the southern or western parts of the sky and kitchens towards the north or east.



Figure 24: In this housing association scheme, solar shading is provided by balconies and overhangs

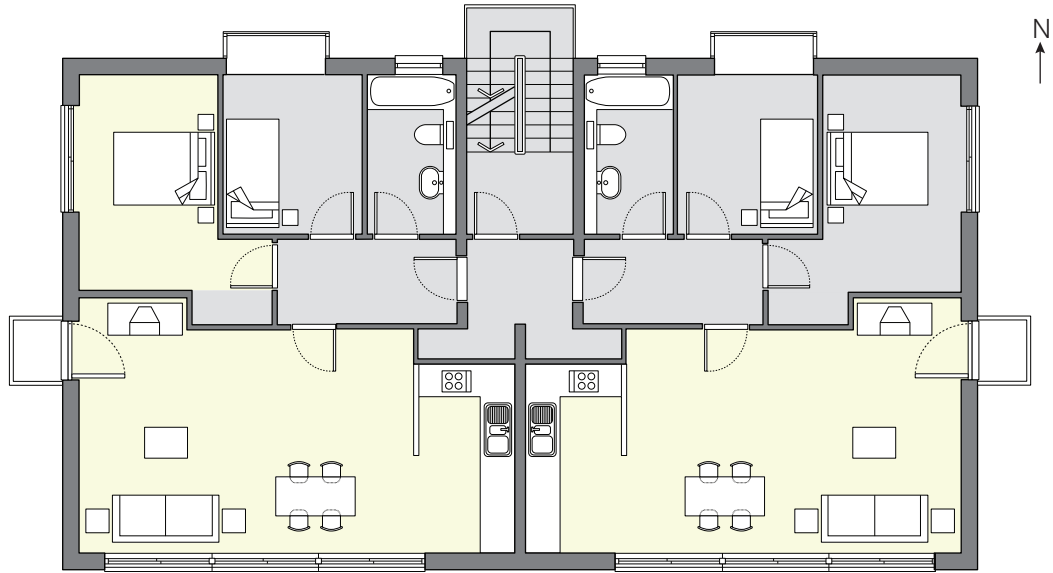

Figure 25: Flats with south-facing living rooms

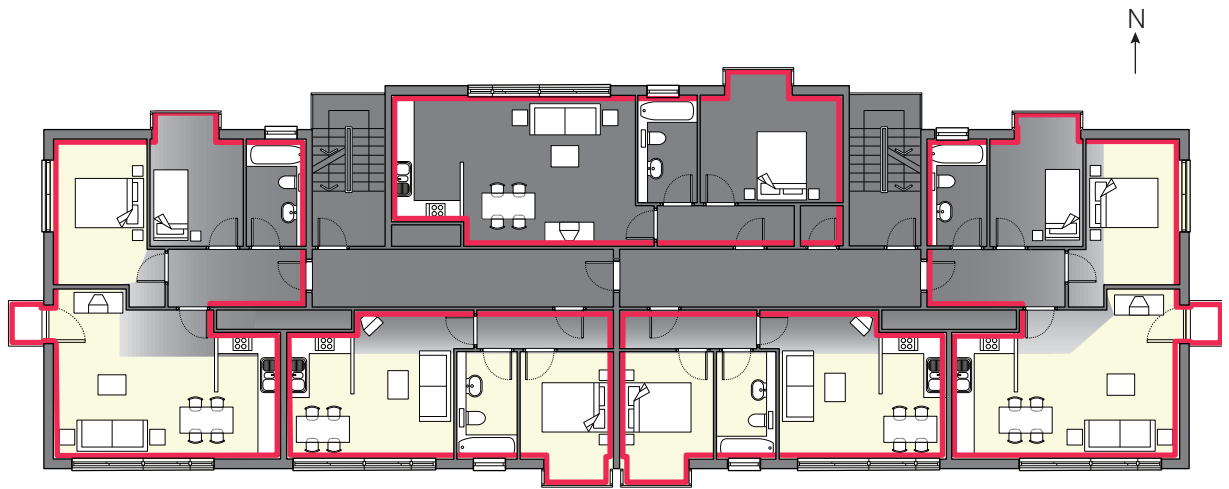

Figure 26: Careful layout design means that four out of the five flats shown have a south-facing living room

3.1.7 The overall sunlighting potential of a large residential development may be initially assessed by counting how many dwellings have a window to a main living room facing south, east, or west. The aim should be to minimise the number of dwellings whose living rooms face solely north, northeast, or northwest, unless there is some compensating factor such as an appealing view to the north.

3.1.8 Figure 25 shows an example of flats where the main living rooms are arranged to face the southern part of the sky. For larger developments of flats, especially those with site constraints, it may not be possible to have every living room facing within 90° of south. However, this can be improved using the following techniques:

- Having access ways and corridors on the north side, and living room windows on the south side.
- Where flats are grouped on both sides of a central corridor, having ancillary areas such as stairwells, lift cores, and bicycle storage on the north side of the building. Figure 26 shows an example where the majority of flats have a south-facing living room.
- Arranging the flats so that living rooms are placed at the end corners of the building and hence can be dual aspect. That way, living rooms on the north side of the building can also have an east- or west-facing window that can receive some sun.

- Alternatively, arranging the flats with a long north-south axis so that living room windows face east and west, and can all receive some sun.

Overshadowing

3.1.9 The overall access to sunlight of a new development can be considerably enhanced if the layout of new buildings is designed with care so that they overshadow each other as little as possible. At a simple level, access to sunlight can be improved by:

- choosing a site on a south-facing slope, if possible, rather than a north-facing one
- having taller buildings to the north of the site with low-rise buildings to the south, but care must be taken not to overshadow neighbouring property (section 3.2)
- having low density housing (semidetached and detached) at the southern end of a site, with terraced housing to the north
- placing terraces on east-west roads (so that one window wall faces nearly south) and semidetached and detached houses on north-south roads
- opening out courtyards to the southern half of the sky
- having garages to the north of houses
- avoiding obstructions to the south such as protruding extensions or other buildings, where window walls face predominantly east or west
- having low pitched roofs on housing.

3.1.10 For interiors, access to sunlight can be quantified. BS EN 17037^[1] recommends that a space should receive a minimum of 1.5 hours of direct sunlight on a selected date between 1 February and 21 March with cloudless conditions. It is suggested that 21 March (equinox) be used. The medium level of recommendation is three hours and the high level of recommendation four hours. For dwellings, at least one habitable room, preferably a main living room, should meet at least the minimum criterion. One of the sunpath indicators in Appendix A (Figures A5, A6, or A7) can be used to calculate hours of sunlight received.

3.1.11 The BS EN 17037 criterion applies to rooms of all orientations, although if a room faces significantly north of due east or west it is unlikely to be met.

3.1.12 If window positions are already known, a reference point on the inside face of the window aperture at the centre of the opening width and at least 1.2 m above the floor and 0.3 m above the sill (whichever is the higher) is used. Sunlight blocked by window reveals and balconies or overhangs above the window should not be included, but the effect of window frames and bars can be discounted. Surrounding obstructions should be modelled in detail, and if this is done a minimum solar altitude, as suggested in BS EN 17037, need not apply. If a room has multiple windows, the amount of sunlight received by each can be added together provided they occur at different times and sunlight hours are not double counted.

3.1.13 At the site layout stage the positions of windows may not have been decided. It is suggested that sunlight availability be checked at points 1.6 m above the ground or lowest storey level on each main window wall, and no more than 5 m apart. If the access to sunlight changes rapidly along a façade it is worthwhile trying to site main windows, particularly of living rooms, where most sunlight is available.

3.1.14 The BS EN 17037 criteria are intended to apply to minimum, medium, and high levels of sunlight in a range of situations. However, in special circumstances the designer or planning authority may wish to choose a different target value for hours of sunlight. If sunlight is particularly important in a building, a higher target value or different target date may be chosen, although the risk of overheating needs to be borne in mind. Section 4 gives guidance on passive solar design. Conversely, if in a particular development sunlight is deemed to be less important but still worth checking for, a lower target value could be used. In either case, the sunpath indicators in Appendix A will still show whether the hours of sunlight received meet the target.

Summary (new buildings)

3.1.15 In general a dwelling, or non-domestic building that has a particular requirement for sunlight, will appear reasonably sunlit provided:

- at least one main window wall faces within 90° of due south and
- a habitable room, preferably a main living room, can receive a total of at least 1.5 hours of sunlight on 21 March. This is assessed at the inside centre of the window(s); sunlight received by different windows can be added provided they occur at different times and sunlight hours are not double counted.

3.1.16 Where groups of dwellings are planned, site layout design should aim to maximise the number of dwellings with a main living room that meets the above recommendations.

3.2 Existing buildings

3.2.1 In designing a new development or extension to a building, care should be taken to safeguard the access to sunlight both for existing dwellings, and for any nearby non-domestic buildings where there is a particular requirement for sunlight. People are particularly likely to notice a loss of sunlight to their homes and if it is extensive then it will usually be resented.

3.2.2 Obstruction to sunlight may become an issue if:

- Some part of a new development is situated within 90° of due south of a main window wall of an existing building (Figure 27)
- In the section drawn perpendicular to this existing window wall, the new development subtends an angle greater than 25° to the horizontal measured from the centre of the lowest window to a main living room (Figure 14).

3.2.3 To assess loss of sunlight to an existing building, it is suggested that all main living rooms of dwellings, and conservatories, should be checked if they have a window facing within 90° of due south. Kitchens and bedrooms are less important, although care should be taken not to block too much sun. Normally loss of sunlight need not be analysed to kitchens and bedrooms, except for bedrooms that also comprise a living space, for example a bed sitting room in an old people's home. In non-domestic buildings any spaces that are deemed to have a special requirement for sunlight should be checked; they will normally face within 90° of due south anyway.

3.2.4 To calculate the loss of sunlight over the year, a different metric, the annual probable sunlight hours (APSH), is used. Here 'probable sunlight hours' means the total number of hours in the year that the sun is expected to shine on unobstructed ground, allowing for average levels of cloudiness for the location in question (based on sunshine probability data^[11]). The sunlight reaching a window is quantified as a percentage of this unobstructed annual total. One of the sunlight availability indicators in Appendix A (Figures A2, A3, or A4) can be used to calculate hours of sunlight received. The APSH is a better way of quantifying loss of sunlight

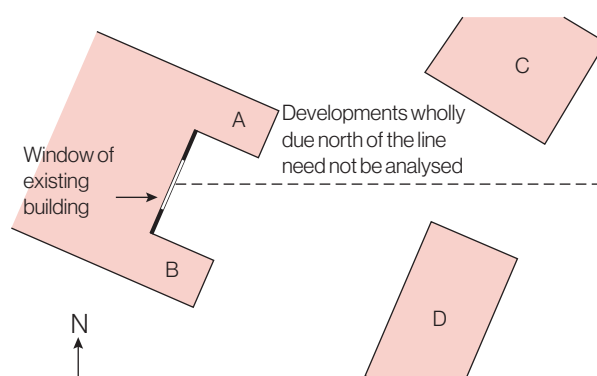

Figure 27: In analysing the sunlighting impact on the existing window, no check need be made for proposed extension A and new building C, as they lie within 90° of due north of the window. Proposed extension B should be checked, as should new building D if it subtends more than 25° to the horizontal, measured in section from the centre of the window

because it takes into account sunlight received over the whole year, not just on one particular date.

3.2.5 A point at the centre of the window on the outside face of the window wall may be taken. In the case of a floor-to-ceiling window such as a patio door, a point on the centre line of the window 1.6 m above the ground (or balcony level in the case of an upper storey window) may be used, again on the plane of the outside surface of the wall. If the main living room to a dwelling has a main window facing within 90° of due north, but a secondary window facing within 90° of due south, sunlight to the secondary window should be checked.

3.2.6 If a room can receive more than one quarter of annual probable sunlight hours (APSH), including at least 5% of APSH in the winter months between 21 September and 21 March, then it should still receive enough sunlight. Also, if the overall annual loss of APSH is 4% or less, the loss of sunlight is small. The sunlight availability indicators (Figures A2, A3 and A4) in Appendix A can be used to check this.

3.2.7 Any reduction in sunlight access below these levels should be kept to a minimum. If the available sunlight hours are both less than the amount above and less than 0.80 times their former value, either over the whole year or just in the winter months (21 September to 21 March), and the overall annual loss is greater than 4% of APSH, then the occupants of the existing building will notice the loss of sunlight; the room may appear colder and less cheerful and pleasant. In presenting results, ratios of sunlight hours should be given to at least two decimal places (for example 0.79 or 0.81) or as the equivalent percentage loss (for example 21% or 19%).

3.2.8 Care needs to be taken in applying this guideline to rooms with multiple windows. Except where the windows are in opposite walls, the annual probable sunlight hours cannot simply be added together. If the calculation method used does not avoid double counting of sunlight through multiple windows, the annual probable sunlight hours for the best sunlit window should be taken.

3.2.9 It is not always necessary to do a full calculation to check sunlight potential. The guideline above is met provided either of the following is true:

- If the distance of each part of the new development from the existing window is three or more times its height above the centre of the existing window (note: obstructions within 90° of due north of the existing window need not count here).
- The window wall faces within 90° of due south and no obstruction, measured in the section perpendicular to the window wall, subtends an angle of more than 25° to the horizontal (Figure 14 in section 2.2). Again, obstructions within 90° of due north of the existing window need not be counted.
- The window wall faces within 20° of due south and the reference point has a VSC (section 2.1) of 27% or more.

3.2.10 In certain situations care needs to be taken in applying these guidelines. For example, if the proposed new development is one of a number of successive extensions to the same building then the total impact on sunlight due to all the extensions should be assessed. On the other hand, if the existing building stands unusually close to the common boundary with the new development, or has a large balcony or overhang above the window, then a greater reduction in sunlight access may be unavoidable. The guidelines are purely advisory. Planning authorities may wish to use different criteria based on the requirements for sunlight in particular types of developments in particular areas. Sometimes a larger reduction in sunlight may be necessary if new development is to match the height and proportion of existing buildings nearby.

3.2.11 Balconies and overhangs above an existing window tend to block sunlight, especially in summer above south-facing windows. Even a modest obstruction opposite may result in a large relative impact on the sunlight received. One way to demonstrate this would be to carry out an additional calculation of the APSH, for both the existing and proposed situations, without the balcony in place. For example, if the proposed APSH with the balcony was under 0.80 times the existing value with the balcony, but the same ratio for the values without the balcony was well over 0.80, this would show that the presence of the

balcony, rather than the size of the new obstruction, was the main factor in the relative loss of sunlight.

3.2.12 It is good practice to check the sunlighting of gardens of existing buildings. This is described in Section 3.3.

Summary

3.2.13 If a living room of an existing dwelling has a main window facing within 90° of due south, and any part of a new development subtends an angle of more than 25° to the horizontal measured from the centre of the window in a vertical section perpendicular to the window, then the sunlighting of the existing dwelling may be adversely affected. This will be the case if the centre of the window:

- receives less than 25% of annual probable sunlight hours and less than 0.80 times its former annual value; or less than 5% of annual probable sunlight hours between 21 September and 21 March and less than 0.80 times its former value during that period;
- and also has a reduction in sunlight received over the whole year greater than 4% of annual probable sunlight hours.

3.3 Gardens and open spaces

3.3.1 Good site layout planning for daylight and sunlight should not limit itself to providing good natural lighting inside buildings. Sunlight in the spaces between and around buildings has an important impact on the overall appearance and ambience of a development. It is valuable for a number of reasons, to:

- provide attractive sunlit views (all year)
- make outdoor activities like sitting out and children's play more pleasant (mainly warmer months)
- encourage plant growth (mainly spring and summer)
- dry out the ground, reducing moss and slime (mainly in colder months)
- melt frost, ice and snow (in winter)
- dry clothes (all year).

3.3.2 The sunlit nature of a site can be enhanced by using some of the techniques described in section 3.1. This could include siting low-rise, low-density housing to the south, with taller, higher density housing to the north of a site; and by opening out courtyards to the southern half of the sky. Special care needs to be taken in the design of courtyards as often they can turn out to be sunless and unappealing.

3.3.3 The availability of sunlight should be checked for all open spaces where it will be required. This would normally include:

- gardens, such as the main back garden of a house or communal gardens including courtyards and roof terraces
- parks and playing fields
- children's playgrounds
- outdoor swimming pools and paddling pools, and other areas of recreational water such as marinas and boating lakes (the daylight and sunlight effects on permanent residential moorings may be assessed using the methods in sections 2.2 and 3.2)
- sitting out areas such as those between non-domestic buildings and in public squares



Figure 28: This outdoor space is in shade all winter. It is grim and underused.

- nature reserves (which may have special requirements for sunlight if rare plants are growing there).

3.3.4 Each of these spaces will have different sunlighting requirements and it is difficult to suggest a hard and fast rule. However, it is clear that the worst situation is to have significant areas on which the sun only shines for a limited period over a large part of the year (Figure 28). The equinox (21 March) can be chosen as a date for assessment here.

3.3.5 Poor sunlighting of outdoor spaces only occurs with certain forms of layout. If a long face of a building faces close to due north then there will be an area adjoining the building that is permanently in shade at the equinox (and hence all winter). Areas slightly farther from such a building face will only receive sunlight for a limited time at the beginning or end of the day.

3.3.6 Areas of this sort can also occur if buildings form an enclosed or partly enclosed space that is blocked off from the southern half of the sky. Figure 29 illustrates some typical examples. It is often possible to redesign the layout so as to minimise these areas, either by reorienting buildings or by opening up gaps to the south in courtyards.

3.3.7 As a check, it is recommended that at least half of the amenity areas listed above should receive at least two hours of sunlight on 21 March. It is instructive to draw the 'two hours sun contour' that marks this area on plan, because the use of specific parts of a site can be planned with sunlight in mind. This could include reserving the sunniest parts of the site for gardens and sitting out, while using the shadier areas for car parking (in summer, shade is often valued in car parks). (Figure 30). If a detailed calculation cannot be carried out, and the area is a simple shape, it is suggested that the centre of the area should receive at least two hours of sunlight on 21 March.

3.3.8 Locations that can and cannot receive two or more hours of sunlight on 21 March may be found using specialist software. The space is divided into a grid of points with a recommended spacing of 0.3 m or less, and the proportion of these points that can receive two hours of sunlight on March 21 is computed. It is possible to carry out a check for the centre of an area by using the sunpath indicator, which has a line for 21 March (see Appendix A). Sunlight at an altitude of 10° or less does not count, because it is likely to be blocked by low-level planting anyway. In working out the total area to be considered, driveways and hard standing for cars should be left out. Around housing, front gardens that are relatively small and visible from public footpaths should be omitted; only the main back garden should be analysed. Each individual garden for each dwelling in a block should be considered separately.

3.3.9 The question of whether trees or fences should be included in the calculation depends upon the type of shade they produce. Normally trees and shrubs need not be included, partly because their shapes are almost impossible to predict, and partly because the dappled shade of a tree is more pleasant than the deep shadow of a building (this applies especially to deciduous trees). Nevertheless, choose locations for tree planting with care. The aim should normally be to have some areas of partial shade under trees while leaving other parts of the garden or amenity area in full sun. Where a dense belt or group of evergreens is specifically planned as a windbreak or for privacy purposes, it is better to include their shadow in the calculation of shaded area (Figure 31). The growth of trees and their likely final size should be allowed for. Appendix G gives more details about shade from trees and hedges.

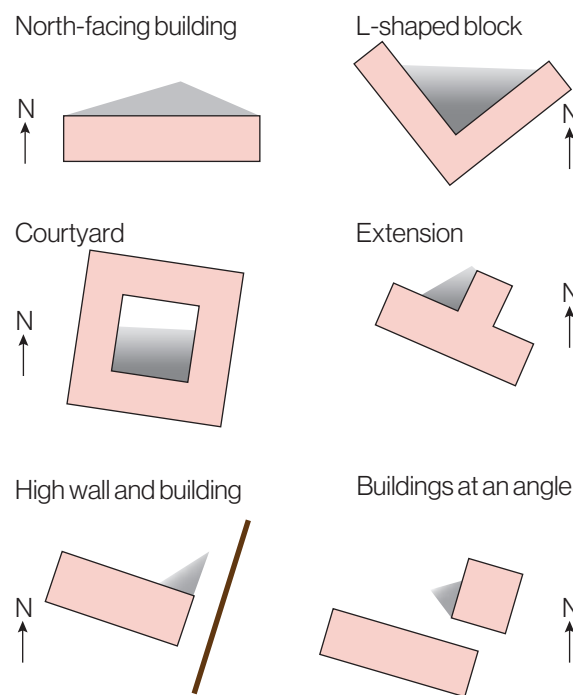

Figure 29: Layouts where poor sunlighting on the ground can occur. The shaded areas will receive no sunlight at the equinox.



Figure 30: Shadier areas can usefully be reserved for car parking



Figure 31: A dense belt of coniferous trees should be treated as an obstruction to sunlight

3.3.10 Fences and walls cast deeper shade than trees and their positions can often be predicted. As a guide, shadows of walls or opaque fences greater than 1.5 m high should be included in the calculation. Where low fences or walls are intended – or railings or trellises that let through sunlight – no calculation of shadows is necessary.

3.3.11 The above guidance applies both to new gardens and amenity areas and to existing ones that are affected by new developments. If an existing garden or outdoor space is already heavily obstructed then any further loss of sunlight should be kept to a minimum. In this poorly sunlit case, if as a result of new development the area that can receive two hours of direct sunlight on 21 March is reduced to less than 0.80 times its former size, then this further loss of sunlight is significant. The garden or amenity area will tend to look more heavily overshadowed.

3.3.12 For critical areas, particularly in public open spaces, it is suggested that a more detailed study of sunlighting potential be carried out, using a prediction tool such as the sunpath indicators (Figures A5, A6, and A7) in Appendix A, or the BRE sunlight availability protractor, or by shadow plotting.

3.3.13 Where a large building is proposed that may affect a number of gardens or open spaces it is often illustrative to plot a shadow plan showing the location of shadows at different times of day and year. This can be done by using the sunpath indicator (Figures A5, A6, and A7 in Appendix A). Alternatively, computer software may be used to plot the shadows. Where there are existing buildings as well as the proposed one, 'before' and 'after' shadow plots showing the difference that the proposed building makes may be helpful. In interpreting the impact of such differences, it must be borne in mind that nearly all structures will create areas of new shadow, and some degree of transient overshadowing of a space is to be expected.

3.3.14 If a space is used all year round, the equinox (21 March) is the best date for which to prepare shadow plots as it gives an average level of shadowing. Lengths of shadows at the autumn equinox (21 September) will be the same as those for 21 March, so a separate set of plots for September is not required. However, under current legislation, clock times of the September shadows will be one hour later, because British Summer Time (BST) is in force then. Shadow plots should state clearly whether the time of the plot is in Greenwich Mean Time (GMT) or BST. At the time of writing, BST is currently in force from April to October inclusive. If a local clock time is used outside the UK, this should also be stated.

3.3.15 As an optional addition, plots for summertime (for example 21 June) may be helpful as they will show the reduced shadowing then, although it should be borne in mind that 21 June represents the best case of minimum shadow, and that shadows for the rest of the year will be longer. Conversely if winter shadows (e.g. 21 December) are plotted, even low buildings will cast long shadows. In a built-up area, it is common for large areas of the ground to be in shadow in December.

3.3.16 If a particular space is only used at certain times of day or year (e.g. a café, outdoor performance area, or school playground) it is instructive to plot shadows for those specific times.

Summary

3.3.17 It is recommended that for it to appear adequately sunlit throughout the year, at least half of a garden or amenity area should receive at least two hours of sunlight on 21 March. If as a result of new development an existing garden or amenity area does not meet the above, and the area that can receive two hours of sun on 21 March is less than 0.80 times its former value, then the loss of sunlight is likely to be noticeable. If a detailed calculation cannot be carried out, it is recommended that the centre of the area should receive at least two hours of sunlight on 21 March.

4. Solar energy

4.1 Introduction

4.1.1 As well as bringing warmth and vitality to exterior and interior spaces, the sun is also a source of energy. Good building design should seek to tap this energy to reduce consumption of conventional fuels. Solar energy may cover:

- passive solar, where the form, fabric, and systems of a building are designed and arranged to capture and use solar energy
- active solar thermal, using solar collectors with pumps or fans to provide water or space heating
- photovoltaic systems, with solar cells to convert sunlight into electricity.

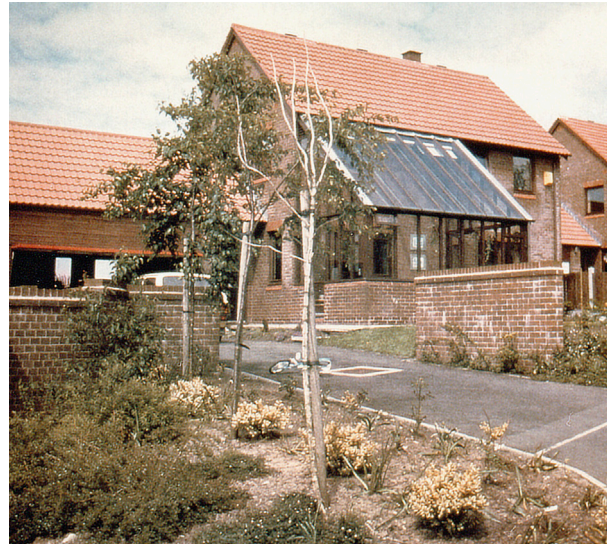

Figure 32: At Willow Park, Chorley, careful road layout design means that all the passive solar homes can have a southerly orientation

4.2 Passive solar energy

4.2.1 Passive solar buildings typically include areas of glazing to collect the sun's heat. This glazing may open directly onto occupied areas, or be used to heat sunspaces or other solar collecting features. Passive solar homes generally have a heating energy consumption significantly lower than conventional housing. These benefits depend on the arrangement of the site to produce the best orientation (closest to the south) and to reduce overshadowing. Even houses with no special design features benefit from solar energy if oriented in a north-south direction without overshadowing.

4.2.2 In deciding whether to opt for passive solar design, the needs of the client and the intended use of the building will be important here. Site related factors also influence the decision. On a sloping site that faces north it will be harder to reap the full benefits of passive solar; conversely a southfacing slope will make it easier. At high densities of development (above 40 dwellings per hectare) it becomes difficult to avoid some houses being seriously obstructed or having a poor orientation. Similarly, on a small site it may be impossible to achieve the best orientation for window walls or to avoid overshadowing by nearby buildings.

4.2.3 These factors need to be carefully considered in passive solar design if the potential energy savings are to be realised. An alternative approach is to concentrate on providing daylight and sunlight as an amenity (sections 2 and 3), and perhaps introduce other energy measures such as improved insulation. The guidance below is intended for those buildings that are specifically designed to make the most of ambient solar energy, when it is intended to supplement the advice in sections 2 and 3.

4.2.4 Passive solar site layout design can be divided into the two key issues: orientation and overshadowing.

Orientation

4.2.5 To make the most of solar gain the main solar collecting façade should face within 30° of due south. Orientations farther east or west than this will receive less solar gain, particularly in winter when it is of most use.

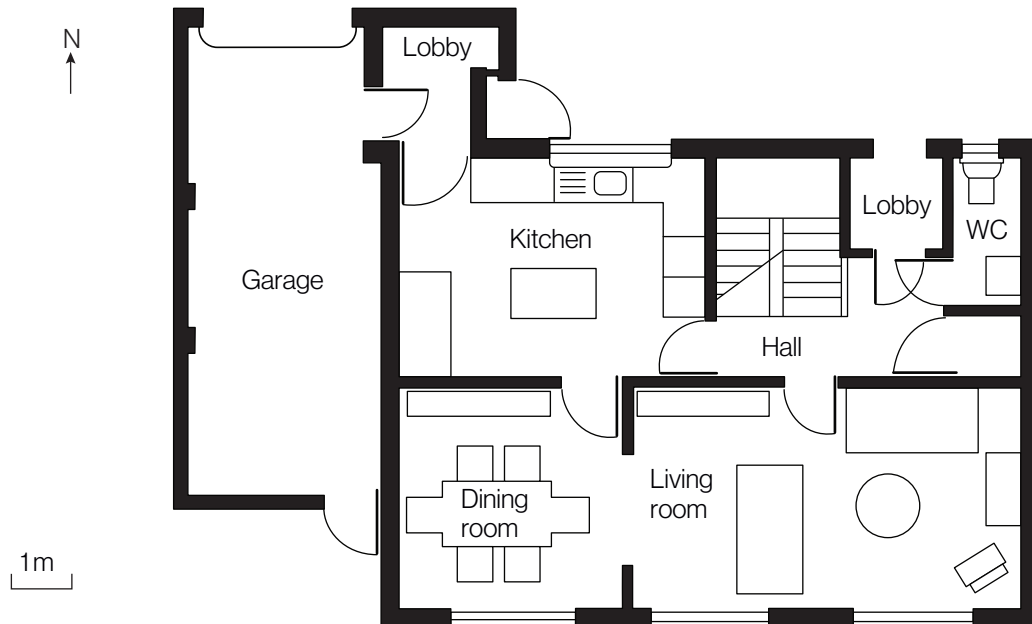

Figure 33: Ground floor plan of Linford low energy house, Milton Keynes

4.2.6 These orientation requirements have considerable influence on site layout. A variety of design solutions are possible, but careful design is needed to offset the monotony that could result from a majority of houses facing south. To achieve a variety of form and spaces, traditional strategies can be used, such as mixing house types, varying the siting within house plots, and good landscaping. Roads will ideally be east-west, but other solutions are possible. (Figure 32).

4.2.7 The individual layout of each building will also be affected. In houses, the solar gain will be used most effectively if living rooms are sited on the south side, with kitchens, bathrooms, and garages to the north (Figure 33). In non-domestic buildings, toilets, storerooms, computer rooms, canteens, and other rooms with high internal heat gains can be located to the north.

Overshadowing

4.2.8 Overshadowing by other buildings can considerably lessen the effectiveness of a passive solar design. A solar collecting façade needs access to low-angle sun in winter when its contribution will be most valuable (Figure 34). In the worst case, with large obstructions to the south, a glazed area may be in shadow all winter but receive large amounts of solar heat gain in summer when it is unwanted.

4.2.9 Overshadowing can be minimised by adopting the measures listed in 3.1. These include having taller buildings and high-density development (such as terraces) to the north of the site, with lower rise, low-density development like bungalows and detached houses to the south. Terraces can be placed on east-west roads so that one window wall faces south; where necessary, detached houses can be located on north-south roads. Roof slopes can be reduced to increase solar access to buildings to the north.

4.2.10 It is also possible to choose plot shapes and the locations of buildings within them to minimise overshadowing. Tree locations are also important; deciduous species are best because they are leafless when solar gains are most valuable, while providing some shade in summer.

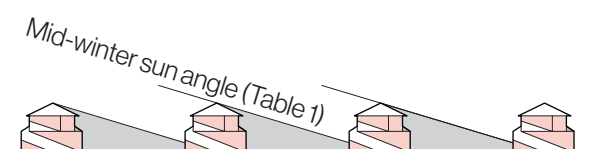

Figure 34: Passive solar homes at Giffard Park, Milton Keynes (top); the terraces at Giffard Park are carefully spaced to avoid winter overshadowing (below)

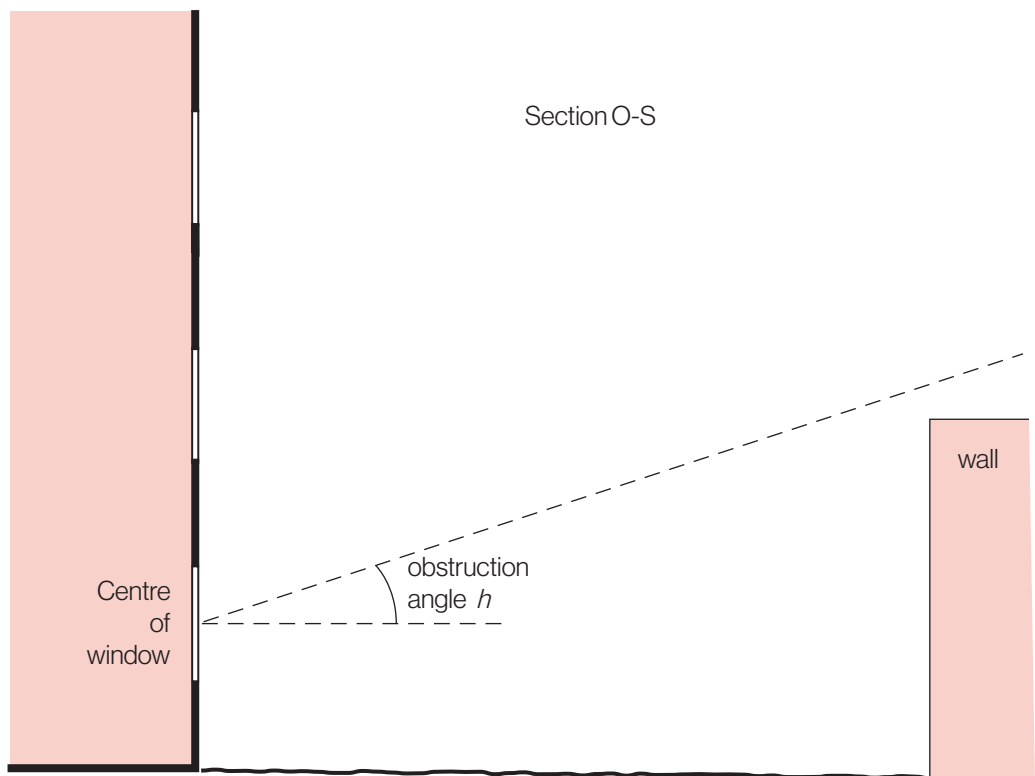
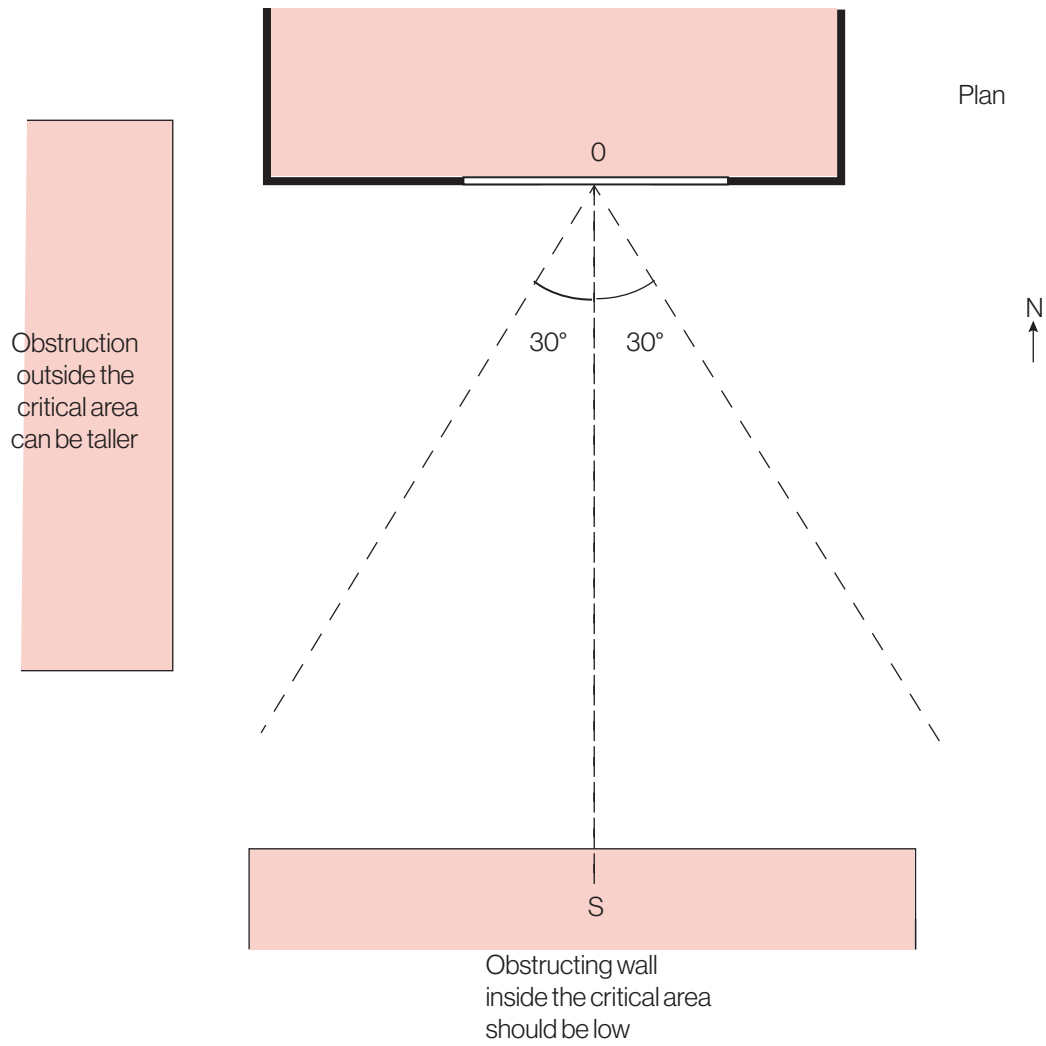

Figure 35: For passive solar gains in winter the sector AOB 30° either side of due south is important. To guarantee winter sun from this sector, obstructions within it should not subtend more than the critical angle h when measured in section. Table 1 gives values for h .

4.2.11 To reap the full benefits of passive solar, maximise winter solar gain as far as other site layout constraints allow. For this purpose the most important area to keep lightly obstructed is within $\pm 30^\circ$ of due south of a solar collecting façade (Figure 35). This is the part of the sky from which most solar radiation comes in the winter months. To check whether solar access from this zone is retained, draw a north-south section (not necessarily perpendicular to the façade). The altitude of any obstructions in it should not exceed the critical angle h when measured from the centre of the solar collecting glazing. Values of h are given in Table 1. If this obstruction angle does not exceed h then at least three hours of sunlight around midday are guaranteed for the period specified – provided the sun shines of course. Note that the values of h are given in terms of site latitude. So if solar gain was required all year at a site in Cardiff (51.5°N) then the maximum obstruction angle h in Figure 35 would be $65^\circ - 51.5^\circ = 13.5^\circ$.



Figure 36: In these passive solar homes, a variety of front door positions and a mixture of garages and car ports produce attractive north façades

Table 1. Limiting obstruction angles h to ensure at least three hours sun in specified period

Period of year	Value of h			
	London	Manchester	Edinburgh	Other location
All year	13°	11°	9°	65° - latitude
21 January to 21 November	17°	15°	12°	68° - latitude
6 February to 6 November	21°	19°	16°	72° - latitude
21 February to 21 October	27°	25°	22°	78° - latitude

4.2.12 It is also important to check whether a passive solar building receives enough diffuse daylight (Section 2.1). This may affect the energy efficiency of the building as well as its attractiveness to the occupants. Special care should be taken to ensure good daylighting to the north side of the building as often minimal window areas are chosen on thermal grounds. (Figure 36).

4.3 Photovoltaics

4.3.1 Photovoltaic (PV) modules are usually mounted on the roofs (pitched or flat) of buildings. In some cases they are mounted vertically^[12,13], either attached to walls or as part of the façade itself. Overshadowing, either from buildings or trees or from nearby obstructions such as chimneys or vents can have a considerable negative impact on PV performance. This depends on the position and orientation of modules on the roof relative to the obstructions, string layout (the way that individual cells and modules are connected) and inverter technology.

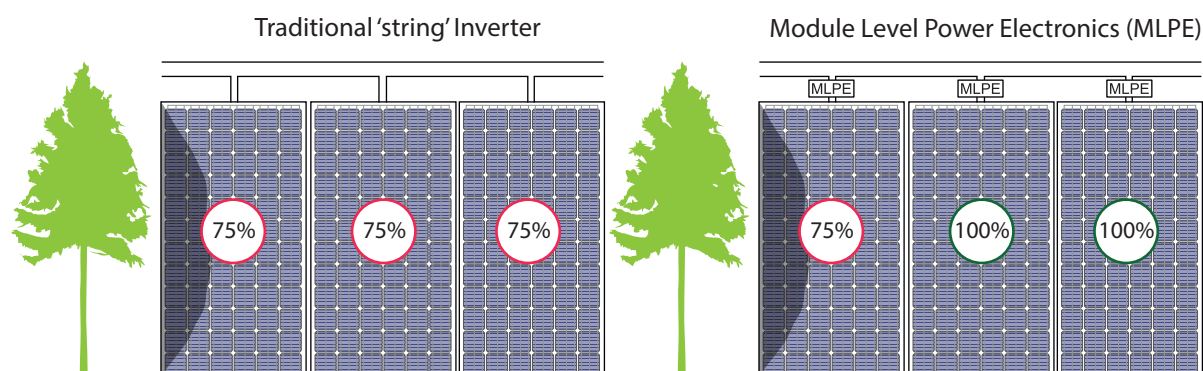

Figure 37: Impact of shading on traditional 'string' inverter and MLPE technologies

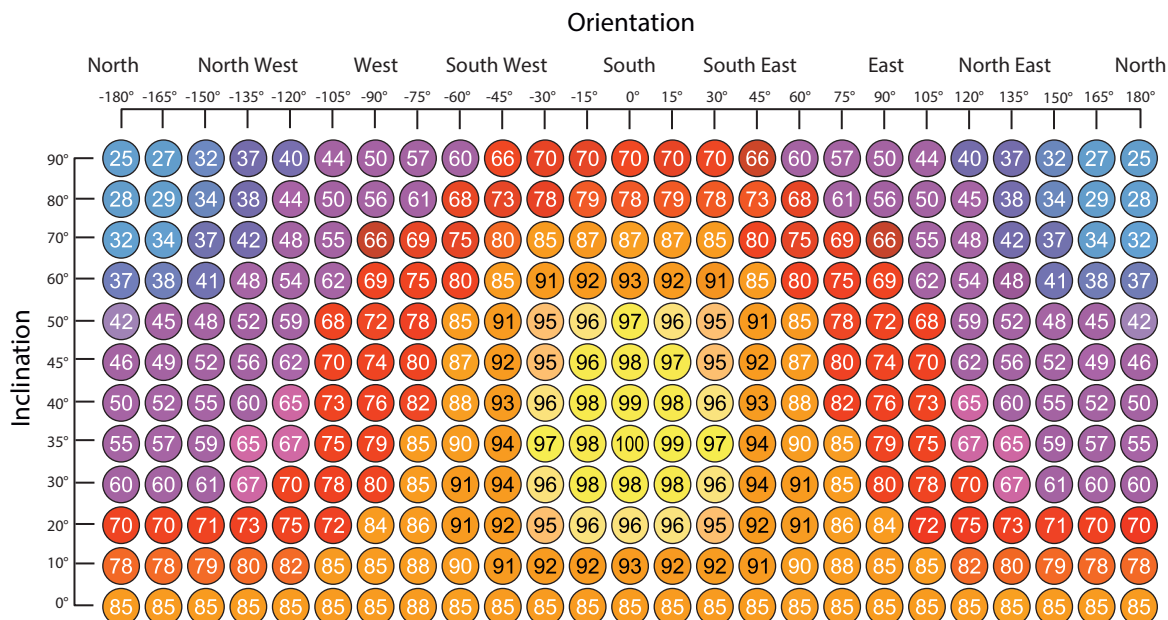

Figure 38: The impact of orientation and inclination on irradiance/ system performance (%) ^[14]

4.3.2 A traditional 'string' inverter can exacerbate the impact of minor overshadowing, because of the series electrical connection between modules. In this case the overall string performance can be limited to the lowest-performing module in that string. For example, if the performance of one module in a string is reduced by 25% then the performance of each module in the string is also reduced by 25%. Emerging module-level power electronics (MLPE) technologies allow modules to operate independently of each other so that only the performance of shaded modules is affected by shading (Figure 37).

4.3.3 Careful design of a new PV system should therefore minimise shading as much as possible and mitigate its impact on system performance where it is unavoidable. An overshadowing assessment should be carried out as part of system design in line with the Microgeneration Certification Scheme (MCS)^[14]. At sites with complex shading a more detailed shading assessment may be required.

4.3.4 On unshaded sites in the UK, the optimum position for irradiance is south facing at 35° tilt. For southeast or southwest facing panels with the same tilt angle, irradiance can be expected to reduce by 6% from optimum on average. Similar east- or west-facing panels would have irradiances 21% lower than optimum. Figure 38 gives values for other orientations and tilts. Note however that in some cases a sub-optimal orientation or tilt angle may be desired to better suit the built form or electrical demands of the building. For example, at sites with increased afternoon electrical demand a more westerly facing system may be desirable.

4.4 Active solar thermal

4.4.1 Overshadowing typically has less impact on the performance of solar thermal installations than on other solar technologies such as photovoltaics (see section 4.5 below). Overshadowing/solar gain analysis can still be valuable where there are sizeable obstructions, and for some low-level collectors, e.g. in solar systems for heating swimming pools.

4.4.2 Orientation and collector tilt are important, and their impact on unshaded collectors can be seen from Figure 38 above.

4.5 General considerations

4.5.1 Where a proposed development of any type is near to an existing solar installation or a building

designed to make use of solar radiation, it is good practice to try to minimise any loss of that solar radiation. However, when locating solar collectors (especially where these form part of the façade) the possibility of future development blocking solar radiation should be anticipated. Solar collectors should stand well back from the southern boundary of the site unless no future development is likely to take place there. It is neither reasonable nor prudent to have a low-level solar collector very close to a southern boundary and expect future development to stand well back from it.

Calculating loss of radiation to solar panels

4.5.2 Where a proposed development may result in loss of radiation to existing solar panels (either photovoltaic or solar thermal), an assessment should be carried out.

4.5.3 For solar PV, it is often the case that the loss of radiation falling on the module is disproportionate to the loss of renewable electricity generation; the latter can be much higher. For example, a module that sees a 25% loss of radiation could see a reduction from 25% to 100% of instantaneous performance, depending on which part of the module surface is shaded. If the array comprises a traditional 'string' inverter (see Figure 37 above) then this performance reduction from a single module can be repeated through the entire string/array.

4.5.4 The guidance below assumes that the PV array uses module-level power electronics (MLPE) so that if part or all of a module is shaded, then the remainder of the array can still perform optimally. If this is not the case (i.e. a traditional 'string' inverter is used) then it can be reasonably assumed that this calculation will underestimate the actual performance loss.

4.5.5 For solar thermal collectors, the loss of radiation falling on the collector is approximately proportional to the loss of renewable heat generation. For example, a collector that has a 25% loss of radiation on its surface would see roughly a 25% reduction in instantaneous performance.

4.5.6 Both scenarios are depicted below in Figure 39.

4.5.7 As an initial check, the annual probable sunlight hours received at the centre of each panel should be calculated with and without the proposed development in place. Existing obstructions, even small ones like chimneys, should be included in both calculations.

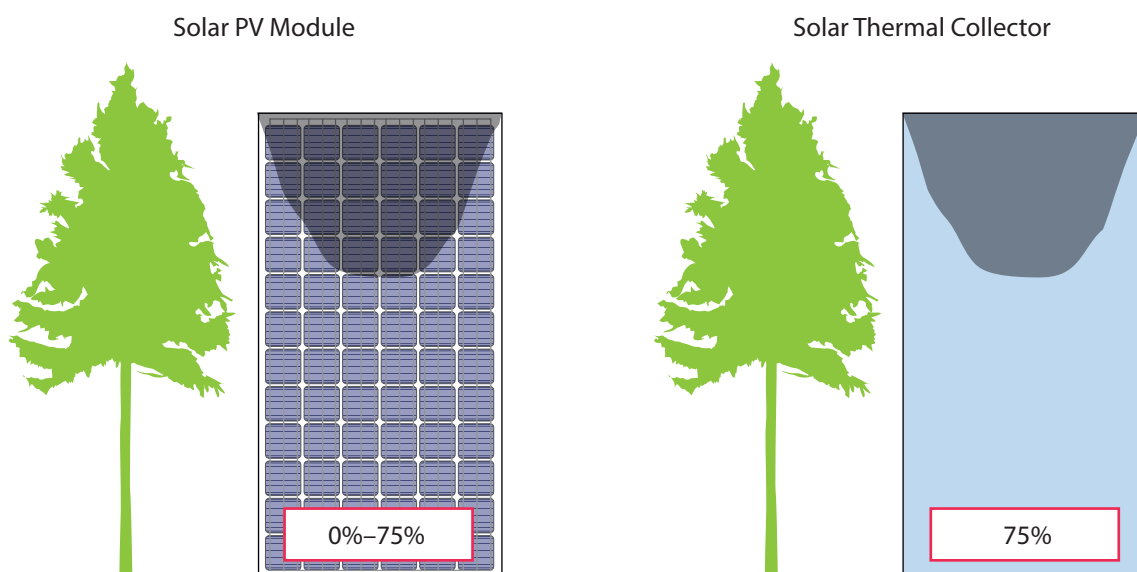

Figure 39: Potential performance reduction from 25% shading on a solar thermal collector compared to a solar PV module.

4.5.8 Where the annual probable sunlight hours received by a solar panel with the new development in place is less than 0.90 times the value before, a more detailed calculation of the loss of solar radiation should be undertaken. This is a specialist type of assessment and expert advice should be sought. The assessment should include both direct solar and diffuse sky radiation; over a whole year, around 60% of the radiation received on a horizontal roof comes from the sky. However, reflected radiation from the ground and obstructions need not be included. The modelling should take account of the effects of cloud in reducing direct solar radiation at different times of year, and include a realistic simulation of the way that incoming solar radiation varies from different parts of the sky.

4.5.9 If over the whole year the ratio of total solar radiation received with the new development, to the existing value is less than the values given in Table 2, then the loss of radiation is significant.

Table 2. Recommended minimum ratios of solar radiation received.

Slope of solar panel in degrees to horizontal	Recommended minimum ratio of radiation received after/before
0-30	0.90
30.01-59.99	0.85
60-90	0.80

4.5.10 Note that numerical values given here are purely advisory. Different criteria may be used based on the requirements for solar energy in an area viewed against other site layout constraints. Another important issue is whether the existing solar panels are reasonably sited, at a sensible height and distance from the boundary. A greater loss of solar radiation may be inevitable if panels are mounted close to the ground and near to the site boundary.

5. Other issues

5.1 Introduction

5.1.1 Daylight and sunlight are only two of the issues that need to be considered at the site layout stage. This section briefly mentions some of the other issues which that may have an impact on the natural lighting of a layout. Further information can be found listed in the Bibliography.

5.2 View

5.2.1 Views out through daylight openings can help building occupants to feel more connected to the outside world and less trapped, and thus have a therapeutic or relaxing effect. This is all the more important where people have to be indoors for long periods.

5.2.2 At the site layout stage in design the needs for view and for daylight rarely conflict; an open, well daylit layout will usually provide reasonable views. There is often a need for specific, close views near to a building, for example for supervision of children playing in a garden, or for security reasons (see below). In this case it may not always be desirable to place windows where they will receive the most daylight or sunlight.

5.2.3 This may constrain the design of passive solar homes. Rooms on the north side of such homes should have enough window area to provide reasonable views out where these are required. This particularly applies to kitchens, which on thermal grounds would normally be sited away from the well glazed south façade.

5.2.4 BS EN 17037 recommends that views out include three distinct layers: sky, landscape, and ground. The landscape layer can include buildings, nature, and/or the horizon only. Generally, a view of nature is preferred to a view of a built environment, as is a wide and distant view to a narrow and near view, and a diverse and dynamic view to a monotonous view. Glazing materials should provide a clear, undistorted, and neutrally coloured view out.

5.2.5 View is assessed from reference points, usually at seated eye height (1.2 m above the floor), within indoor living or working areas. The method is most applicable to spaces with fixed seating locations such as offices and schools; it is less relevant to housing where people can move about in order to see out. For any reference point, the quality of view is given by the size of the daylight opening(s), the width (measured by the horizontal sight angle) and outside distance of view, the number of layers seen, and the quality of environmental information perceived (such as location, time, weather, nature, and people).

5.2.6 BS EN 17037^[1] rates views as minimum, medium, or high. The minimum level of recommendation is achieved if the horizontal sight angle is at least 14°, the outside distance of view is at least 6 m, and at least the landscape layer is visible from not less than 75% of the reference points in the living or working area; the view should provide environmental information on location, time, and weather.

5.2.7 View out can be classified through a simplified method in Appendix C of BS EN 17037 based on architectural drawings and view width, or through an advanced method that uses fisheye projections.

5.3 Privacy

5.3.1 Privacy of houses and gardens is a major issue in domestic site layout. Overlooking, both from public roads and paths, and from other dwellings, needs to be considered. The way in which privacy is achieved will have a major impact on the natural lighting of a layout. One way is by remoteness; by arranging for enough distance between buildings, especially where two sets of windows face each other. Distance helps promote visual privacy but does not guarantee it. An early study^[15] suggests complete visual privacy indoors is only achieved at distances of 90 m or more. Recommended privacy distances are usually less than this but vary widely, typically from 18 m up to 35 m. A spacing to height ratio of just over two is normally enough to allow adequate daylighting on building faces; thus for lowrise housing, if these privacy distances are applied, good natural lighting in the layout will ensue automatically. However smaller-scale checks, e.g. of overshadowing by extensions, may still be necessary.

5.3.2 The second way of achieving privacy is by design; high walls, projecting wings and outbuildings block direct views of interiors. In this situation natural lighting is often reduced, both because the visual screens themselves block it, and because the spacing between buildings may be much less. To achieve good sunlight and daylight in this type of layout the guidance in Sections 2 and 3 needs to be followed carefully.

5.3.3 Trees, hedges (Appendix G), fences, and walls can all provide screening and enhance privacy. However, they also tend to block daylight and sunlight. For visual privacy, screens need to be above standing eye height. Higher screens will block more sunlight and daylight with little extra privacy benefit. Completely opaque barriers give the best privacy but block most light. Porous fences and hedges give a degree of privacy which is enhanced if:

- the holes are neither too large, nor very small and regular^[16]
- people outside cannot go right up to the barrier to peer through
- the barrier is light coloured, superimposing a bright distracting pattern on the view in^[16]
- the barrier has depth, restricting viewing angles into the property.

For shielding of gardens, deciduous hedges and shrubs may be an acceptable compromise. They let through sunlight in winter, but provide effective screening in summer when most outdoor activities take place.

5.3.4 Where external protection cannot provide visual privacy, windows may need to be screened in some way:

- Diffusing glass lets through light but does not allow a view out. A fine diffusing texture is required on the glass otherwise a distorted view may be possible. Frosted glass often has an overall transmittance similar to, or slightly less than, clear glass. Fritted glass usually has a lower transmittance.
- Reflective glass or light-coloured net curtains allow a view, but are ineffective at night^[17]. Reflective glass also reduces the amount of daylight entering.
- Narrow windows with deep reveals restrict viewing into property, but reduce incoming daylight and sunlight.
- A conservatory; although it may be possible to see into the conservatory, it will be less easy to see into the living rooms behind it.
- Adjustable curtains or shutters allow the occupants to control the degree of privacy.

5.4 Security

5.4.1 There may be occasional conflicts between site layout design to provide sunlight and daylight, and security requirements. These may occur in a number of ways.

- To ensure good overall sunlight and daylight in a housing estate it is usually better to space out dwellings evenly, while grouping homes in small clusters promotes neighbourliness and natural surveillance.

- It may be necessary to erect high walls or fences, e.g. where the rear of a property faces open ground.
- Windows may need to be positioned so that occupants can view areas immediately adjacent to a building. These may not be the best positions for access to sunlight and daylight.
- For maximum sunlight in gardens and planted areas it is best to park cars in shaded areas. However, for security, cars should be easily seen from the occupied building.

5.4.2 These conflicts can usually be resolved by careful site layout design.

5.5 Access

5.5.1 With careful site layout planning it is possible to satisfy the needs for both pedestrian and vehicle access, and adequate sunlight and daylight. The spaces required by roads and footpaths will bring sunlight and daylight into a layout. Tall buildings can be sited to the south of larger road junctions where they will cast shadows on roads rather than on other buildings.

5.5.2 Nevertheless there is often a threeway conflict between good natural lighting, access, and privacy (section 5.3). For maximum privacy large windows should not face roads or other public spaces, even though they would probably receive most sunlight and daylight there. In practice this problem may be overcome by having private zones such as front gardens, or shading devices like net curtains.

5.5.3 Problems with road and footpath layouts may occur in passive solar estates. The best type of road pattern for solar access is a series of long east-west roads with shorter north-south link roads. However, in residential areas shorter, curving roads are usually favoured because this will reduce traffic speed and produce a succession of smaller, more restful looking spaces. Such a road layout will require greater imagination in the design of passive solar housing. Detached houses or houses with roof collectors may be used on north-south roads, perhaps with gable ends facing the road.

5.6 Enclosure

5.6.1 To achieve good natural lighting within a site, there needs to be enough space between buildings. However, in built up areas the perceived quality of an outdoor space may be reduced if it is too wide and long compared to the height of the buildings that surround it. It may lack human scale and a sense of enclosure.

5.6.2 For higher densities it is still possible to retain a sense of enclosure along with reasonable sunlight and daylight. In linear spaces, such as a street between two rows of terraces, a spacing-to-height ratio of 2.5 would still appear enclosed but not obstruct too much natural light. Conflicts can occur in courtyards. It has been suggested that to appear as an enclosed space a courtyard should have a spacing-to-height ratio of 4 or less. However, courtyards of this shape, completely enclosed on all four sides, will have less than ideal natural lighting. Rooms lit by windows near the corners of the courtyard may appear gloomy and heavily obstructed, and sunlight will only reach half at most of the courtyard in winter.

5.6.3 Such problems can be overcome in a number of ways:

- Including gaps between buildings, especially on the south side of a courtyard, will improve access to sunlight and daylight. If the gaps are not too large the space will still appear reasonably enclosed.
- A larger space between buildings can be 'broken up' by vegetation or well-defined changes in ground level, into what appears to be a number of smaller spaces.
- Reducing the width of an outdoor space and the height of the enclosing buildings, while keeping the ratio of the two the same, will increase the sense of enclosure while slightly increasing the natural light available at window head level.
- In some circumstances the need for daylight at ground floor level may not be so great, e.g. where shops occupy the ground floor. Alternatively the ground floor areas could be reduced and they could be lit primarily from the less obstructed side.

- Smaller spacings could be compensated for by increasing window size, especially window head height, and decreasing room depth. This is the approach adopted in Georgian buildings (Figure 3). Appendices C and F give advice on how to achieve this.

5.7 Microclimate

5.7.1 Access to daylight and sunlight is an important aspect of the microclimate around buildings. The other main element of microclimate is shelter, either from the wind or from excessive solar heat gain in summer. There may be a conflict between shelter and solar access requirements. The BRE report *Environmental site layout planning*^[3] and BRE Digest 350^[18] deal with this issue in detail; only an outline is given here.

5.7.2 Measures to provide shelter from the wind may compromise access to natural light, e.g.:

- the planting or construction of windbreaks
- the plugging of gaps between buildings through which wind could rush
- the reduction of distances between buildings so that they partly shield each other.

5.7.3 A compromise solution will depend on how exposed the site is. On a particularly exposed site it may be necessary to plant rows of conifers for use as windbreaks, even if this reduces levels of daylight. Figure 40 shows ways to make individual buildings less sensitive to wind without necessarily affecting natural light.

5.7.4 Summertime shade can be provided in a number of ways. Deciduous trees give shade in summer but allow access to sunlight and daylight in winter. Buildings can incorporate shading devices such as overhangs which block high angle summer sun. Making building surfaces a light colour will reduce

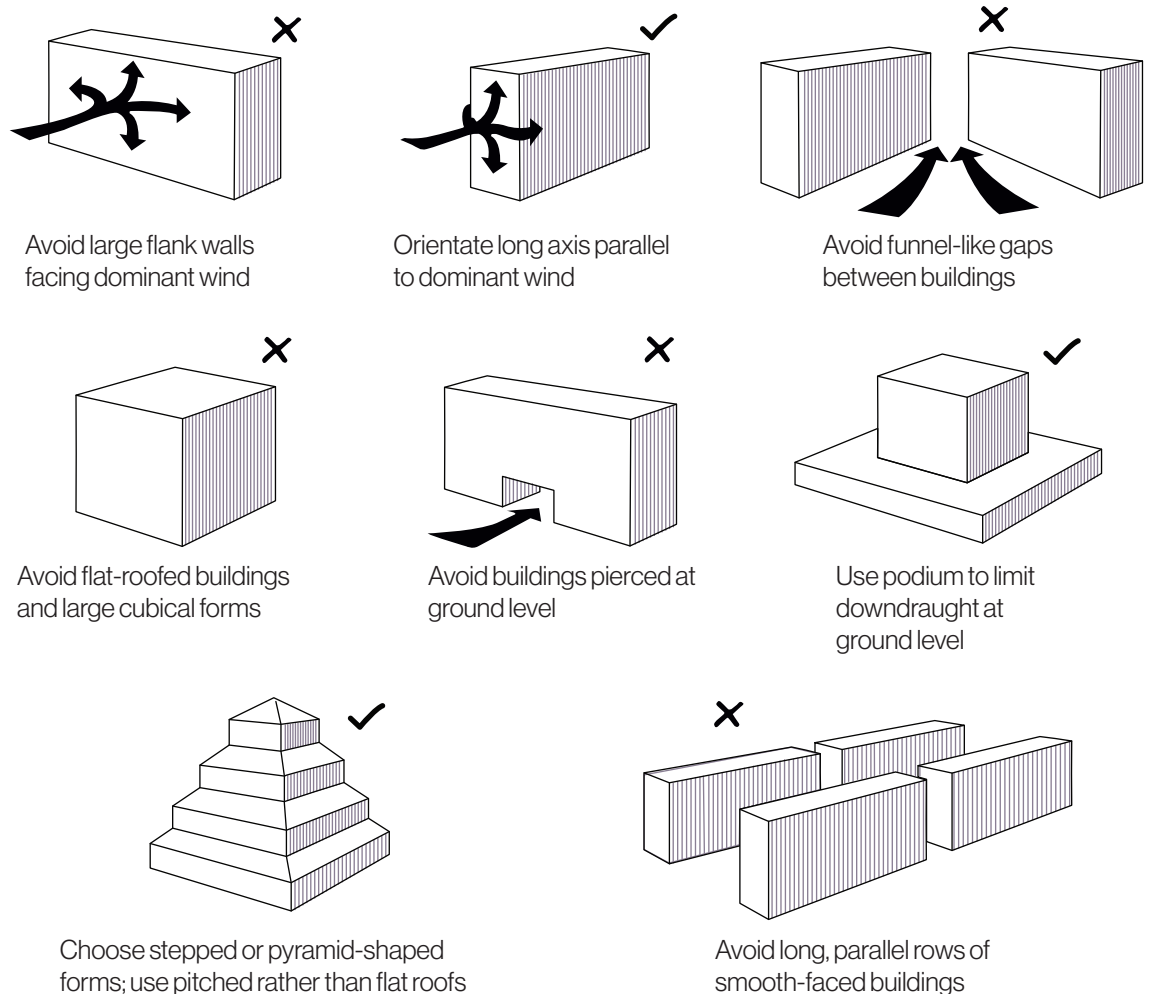

Figure 40: Reducing the wind sensitivity of buildings

absorbed radiation and improve reflected light^[19]. Site features like lakes and vegetation can reduce summer temperatures by evaporative cooling and thermal storage.

5.8 Solar dazzle

5.8.1 Glare or dazzle can occur when sunlight is reflected from a glazed façade (Figure 41) or area of metal cladding. There are two types of reflected glare problem that can occur. Discomfort glare causes visual discomfort without necessarily affecting the ability to see. Disability glare happens when a bright source of light (such as the reflected sun) impairs the vision of other objects. The bright light is scattered in the eye, making it harder to see everything else. Outdoors, disability glare is easily the more serious problem, as it can affect motorists' and train drivers' ability to drive safely^[20].



Figure 41: Solar dazzle reflected from a glazed façade

5.8.2 The problem can occur either when there are large areas of reflective glass or cladding on the façade, or when there are areas of glass or cladding that slope back so that high altitude sunlight can be reflected along the ground (Figures 42 and 43). Thus solar dazzle is only a long-term problem for some heavily glazed (or mirror clad) buildings. Photovoltaic panels generally tend to cause less dazzle because they are designed to absorb light.

5.8.3 If it is likely that a building may cause solar dazzle the exact scale of the problem should be evaluated. This is done by identifying key locations such as road junctions and railway signals, and working out the number of hours of the year that sunlight can be reflected to these points. BRE Information Paper IP 3/87^[21] gives details.

5.8.4 Where solar reflection can happen, the next step is to calculate the angle between the driver's line of view and the reflected sun. For vertically mounted clear double glazing facing a driver on a level road, solar dazzle could be a significant issue if this angle is less than 10° . With a sloping façade or high reflectance glazing or cladding, solar dazzle might be a problem at higher angles of view as well. Sunlight that reflects off the façade at a glancing angle might also be bright enough to cause problems at higher angles of view.

5.8.5 If the reflected sun would be visible close to the driver's line of sight, even if this only happens for a small numbers of hours per year, then either a more detailed calculation of solar glare is required, or measures should be taken to reduce the glare.

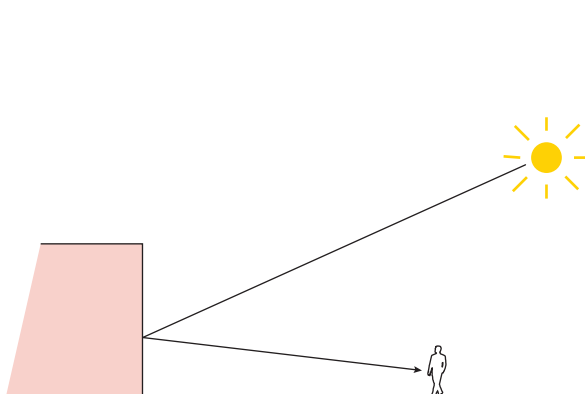

Figure 42: Reflection of low angle sunlight from a vertical façade

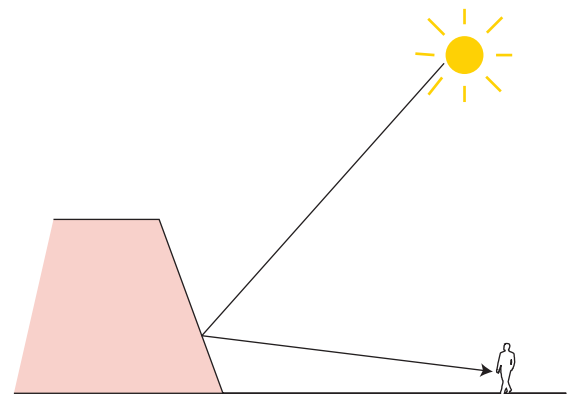

Figure 43: Reflection of high angle sunlight from a sloping façade

5.8.6 At the design stage, solar dazzle can be mitigated by reducing areas of glazing, reorienting the glazing, or replacing areas of tilted glass by either vertical or nearly horizontal glazing. Substituting clear, absorbing textured or diffusing glass for reflective glass can also help, although sometimes even clear glass may cause reflected glare if, e.g., a motorist has the reflected sun close to the centre of their line of sight. As an alternative mitigation measure, some form of opaque screening may be acceptable. External shading such as louvres or motorised blinds can be used. Vertical fins may be effective in situations where the sun is reflected off a building at a glancing angle.

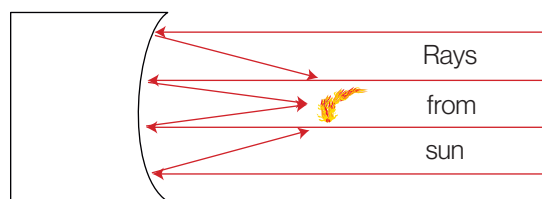
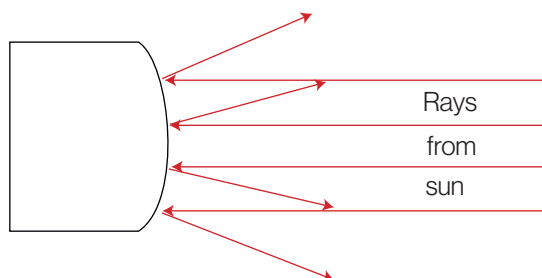
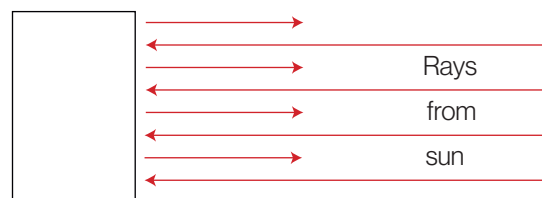

Figure 44: Solar reflection from flat, convex and concave facades. Only a concave face can focus and concentrate the sun.

5.9 Solar convergence

5.9.1 Solar convergence^[22] can happen when a reflective structure has a concave arrangement of elements that focus the sun's rays. The structure can be concave on plan, in section, or both. Flat and convex facades do not concentrate the sun (Figure 44).

5.9.2 Solar convergence creates a relatively small area of concentrated solar radiation. Within this area, various adverse effects could occur:

- damage to people's eyes from looking at the reflected sun
- burns to people's skin, either directly from the radiation or from touching hot objects like metal railings or door handles
- local overheating, for example if someone is in a parked car
- damage to materials
- in extreme circumstances, materials could smoulder or catch fire.

5.9.3 If a concave reflective façade or other building element is proposed, a detailed study should be carried out to predict whether solar convergence can happen, where it occurs, and the maximum solar radiation levels. This is a specialist type of assessment and expert advice should be sought. Modelling of reflection should be carried out for the full range of days and times of year when the sun can shine on the façade.

5.9.4 Overall, it is recommended that no area, even at roof level, should receive a solar irradiance of 10kW/m² or above. Areas where people are likely to be present (including windows to occupied rooms) should not receive a solar irradiance of more than 2.5kW/m² for more than 30 seconds. For areas at street level where people are present, areas with reflected irradiances above 1.5kW/m², and preferably those above 1kW/m², should be minimised.

5.9.5 At the design stage, it is possible to avoid solar convergence by reconfiguring the building, for example by replacing a concave reflecting element with a flat or convex one. If a concave element is required, it may be possible to redesign it so that the convergence occurs in mid-air away from existing or potential future buildings, or in an inaccessible location. Another way to avoid solar convergence is to use matt or diffusing materials instead of mirror-like ones or low reflectance glazing; to reduce localised heating this should have a low reflectance in the infrared as well as the visible spectrum, although this may affect solar overheating within the proposed building itself. External shading like louvres and fins, or motorised external blinds, can intercept the sunlight and stop it being reflected.

6. References

1. BSI. Daylight in buildings. BS EN 17037. London, BSI, 2018.
2. CIBSE (Chartered Institution of Building Services Engineers) Daylighting – a guide for designers. LG 10. London, CIBSE, 2014.
3. Littlefair P.J. et al. Environmental site layout planning: solar access, passive cooling and microclimate in urban areas. BRE Report BR380. Bracknell, IHS BRE Press, 2000.
4. Department for Education. Technical Annex 2E: Daylight and Electric Lighting Output Specification. London, DfE, May 2020
5. BSI. Code of practice for daylighting. BS 8206-2:2008. London, BSI, 2008.
6. Energy Saving Trust (EST). Reducing overheating: a designer's guide. CE 129. London, EST, 2005.
7. Good Homes Alliance. Overheating in new homes. London, GHA, 2019.
8. Royal Institution of Chartered Surveyors (RICS). Rights of light – Practical guidance for chartered surveyors in England and Wales. London, RICS, 2010.
9. Ne'eman E., Craddock J., and Hopkinson R.G. Sunlight requirements in buildings—I. Social survey. *Building and Environment*, 1976 11: 217-238.
10. Littlefair P.J. 'Solar shading of buildings' was redone in 2018. BRE BR364, Bracknell, IHS BRE Press, 1999.
11. Littlefair P.J. and Aizlewood M.E. Calculating access to skylight, sunlight and solar radiation on obstructed urban sites in Europe. BRE BR379. Bracknell, IHS BRE Press, 2000.
12. Baker P. and Stirling C. Photovoltaics: integration into buildings. BRE DG 438. Bracknell, IHS BRE Press, 1999.
13. Boyd P., Coonick C., and Longfield A. BIPV in Construction: the translation of products and systems into design and construction. Garston, BRE, 2018.
14. MCS/ECA. Photovoltaics in Buildings: Guide to the installation of photovoltaic systems. London, MCS/ECA, 2012.
15. Manthore W. Machinery of sprawl. *Architectural Review* 1956, 120: 409–422. Quoted in Finighan W.R. *Privacy in suburbia: a study of four Melbourne areas*. Melbourne, CSIRO, 1979.
16. Hill A.R. and Markus T.A. Some factors influencing vision through meshes. *Proceedings of the Royal Society A*, 1969, 312: 13-29, 1969.
17. Treado S.J. and Bean J.W. Optical performance of commercial windows. NISTIR, 1992, 4711, Gaithersburg, Maryland, NIST.
18. BRE. Climate and site development: Part 1: General climate of the UK; Part 2: Influence of microclimate; Part 3: Improving microclimate through design. BRE DG 350. Bracknell, IHS BRE Press, 1983.
19. Smith J. Designing urban streets to minimise heat island effects. Information Paper IP19/10. Bracknell, IHS BRE Press, 2010.
20. City of London. Planning Advice Note: Solar Glare. Guidelines and best practice for assessing solar glare in the City of London. London, City of London Corporation, 2017.
21. Littlefair P.J. Solar dazzle reflected from sloping glazed façades. BRE IP 3/87. Bracknell, IHS BRE Press, 1987.
22. City of London. Planning Advice Note: Solar Convergence. Guidelines and best practice for assessing solar convergence in the City of London. London, City of London Corporation, 2017.

7. Bibliography

Daylighting/sunlighting

BRE. Sunlight availability protractor. BR12. Bracknell, IHS BRE Press, 1975.

BSI. Daylight in buildings. BS EN 17037. London, BSI, 2018.

CIBSE (Chartered Institution of Building Services Engineers) LG 10 Daylighting – a guide for designers. London, CIBSE, 2014.

Baker N., Fanchiotti A., and Steemers K. Daylighting in architecture: A European reference book. London, James and James, 1993.

Bell J. and Burt W. Designing buildings for daylight. BRE BR288. Bracknell, IHS BRE Press, 1995.

Crisp V.H.C., Littlefair P.J., Cooper I., and McKennan G. Daylight as a passive solar energy option: an assessment of its potential in non-domestic buildings. BRE BR129. Bracknell, IHS BRE Press, 1988.

Energy Saving Trust (EST). Daylighting in urban areas. London, EST, 2007.

Littlefair P.J. and Aizlewood M.E. Calculating access to skylight, sunlight and solar radiation on obstructed urban sites in Europe. BRE BR379. Bracknell, IHS BRE Press, 2000.

Ne'eman E. and Light W. Availability of sunshine. BRE CP 75/75. Bracknell, IHS BRE Press, 1975.

Phillips D. Daylighting: natural light in architecture. Oxford, Architectural Press, 2004.

Tregenza P. and Wilson M. Daylighting: architecture and lighting design. Abingdon, Routledge, 2011.

Rights to light

Anstey J. and Harris L. Anstey's rights of light. London, RICS, 2006.

Barnes M. The law of rights of light. Oxford, Hart Publishing, 2016.

Bickford Smith S. and Francis A. Rights of light: the modern law. Bristol, Jordans, 2021.

Karas J. The law of rights of light. London, Wildy, Simmonds and Hill, 2016.

Redler A. Practical neighbour law handbook. London, RICS, 2006.

RICS. Rights of light. London, RICS, 2016.

Solar design

Boyd P., Coonick C., and Longfield A. BIPV in Construction: the translation of products and systems into design and construction. Garston, BRE, 2018.

Brown G.Z. and DeKay M. Sun, wind and light: architectural design strategies. New York, Wiley, 2014.

Halliday S. Sustainable construction. Abingdon, Routledge, 2018.

Knowles R.L. Ritual house: drawing on nature's rhythms for architecture and urban design. Washington, Island Press, 2006.

MCS/ECA. Photovoltaics in Buildings: Guide to the installation of photovoltaic systems. London, MCS/ECA, 2012.

Roberts S. and Guariento N. Building integrated photovoltaics: a handbook. Basel, Birkhauser, 2009.

Other issues

BSI. BS 5837 Trees in relation to design, demolition and construction – recommendations. London, BSI, 2012.

Biddulph M. Introduction to residential layout. Oxford, Architectural Press, 2007.

Buxton P. (ed). Metric handbook: planning and design data. Abingdon, Routledge, 2018.

Graves H., Watkins R., Westbury P., and Littlefair P.J. Cooling buildings in London: overcoming the heat island. BRE BR431, Bracknell, IHS BRE Press, 2001.

Littlefair P.J et al. Environmental site layout planning: solar access, passive cooling and microclimate in urban areas. BRE BR380, Bracknell, IHS BRE Press, 2000.

Littlefair P.J. Hedge height and light loss. London, Office of the Deputy Prime Minister, 2005.

Smith J. Designing urban streets to minimise heat island effects. Information Paper IP19/10. Bracknell, IHS BRE Press, 2010.

BRE Digests

Climate and site development: Part 1: General climate of the UK; Part 2: Influence of microclimate; Part 3: Improving microclimate through design. DG 350. Bracknell, IHS BRE Press, 1983.

Photovoltaics: integration into buildings. DG 438, IHS BRE Press, 1999.

Selecting lighting controls. BRE Digest 498. Bracknell, IHS BRE Press, 2006.

BRE Information Papers

Littlefair P.J. Solar dazzle reflected from sloping glazed façades. IP 3/87. Bracknell, IHS BRE Press, 1987.

Littlefair P.J. Innovative daylighting systems. IP 22/89. Bracknell, IHS BRE Press, 1989.

Littlefair P.J. Measuring daylight. IP23/93. Bracknell, IHS BRE Press, 1993.

Littlefair P.J and Aizlewood M E. Daylighting in atrium buildings. IP3/98. Bracknell, IHS BRE Press, 1998.

Littlefair P.J. Developments in innovative daylighting. IP9/00. Bracknell, IHS BRE Press, 2000.

Littlefair P.J. Solar energy in urban areas. IP5/01. Bracknell, IHS BRE Press, 2000.

Smith J. Designing urban streets to minimise heat island effects. IP19/10. Bracknell, IHS BRE Press, 2010.

Appendix A: Indicators to calculate access to skylight, sunlight, and solar radiation

A1 General

A1.1 This appendix contains indicators to find how much skylight and sunlight reach the outside of a window. These comprise the:

- i. skylight indicator (Figure A1), to find the vertical sky component (VSC) (in %) on the outside of a window wall (Section 2).
- ii. sunlight availability indicators (Figures A2 to A4) to find the probable sunlight hours received by a window wall, or at any other point in a building layout (sections 3.1 and 3.2).
- iii. sunpath indicators (Figures A5 to A7) to find the times of day and year for which sunlight is available on a window wall or point in a layout.

A1.2 The sunlight availability and skylight indicators each come in three different versions according to the latitude of the site in question. The indicators marked 'London 51.5°N' may be used for southern England. The 'Manchester 53.5°N' ones are for northern England and the southern half of Northern Ireland. For Scotland and the northern half of Northern Ireland the 'Edinburgh/Glasgow 56°N' indicators may be used.

A1.3 Indicators for other locations in Europe are given in a separate BRE Report *Calculating access to skylight, sunlight and solar radiation on obstructed urban sites in Europe*^[A1], which also explains how the indicators were constructed.

A1.4 The skylight indicator is independent of latitude and may be used anywhere.

A1.5 The skylight indicator is semi-circular; the sunlight availability and sunpath indicators are shaped like a circle with a segment removed. In each case the centre of the circular arc corresponds to the reference point at which the calculation is carried out. Radial distances from this point correspond to the ratio of the distance of the obstruction on plan divided by its height above the reference point. So if the reference point were 1.5 m above ground, and the ground were flat, this height would be the obstruction height above ground, minus 1.5 m. The indicators are all drawn to the same scale so that it is easy to calculate a number of different quantities at the same time. They should be printed out so that the radius of the indicators is 10 cm.

A1.6 Directions on the indicator from the central point correspond to directions on the site plan. The skylight indicator is used with its straight base parallel to the window wall. The sunlight availability and sunpath indicators, however, are always used with the south point of the indicator pointing in the south direction on plan, whatever the orientation of the window wall.

A1.7 These indicators are not intended to be laid over standard scale site plans because the distance scale on the indicator is unlikely to correspond to the scale of the plan. To plot a layout on the indicator either the direction finder may be used, or a plan may be specially drawn to the exact scale of the indicator.

Use of the direction finder

A1.8 This is given in Figure A8. It is possible to create a direction finder by printing Figure A8 onto an acetate sheet (take care that the type of acetate is suitable for the printer being used), or tracing paper. If done correctly, the radius of the outer circle of the direction finder should be 10 cm, and it should fit neatly onto the skylight indicator (Figure A1).

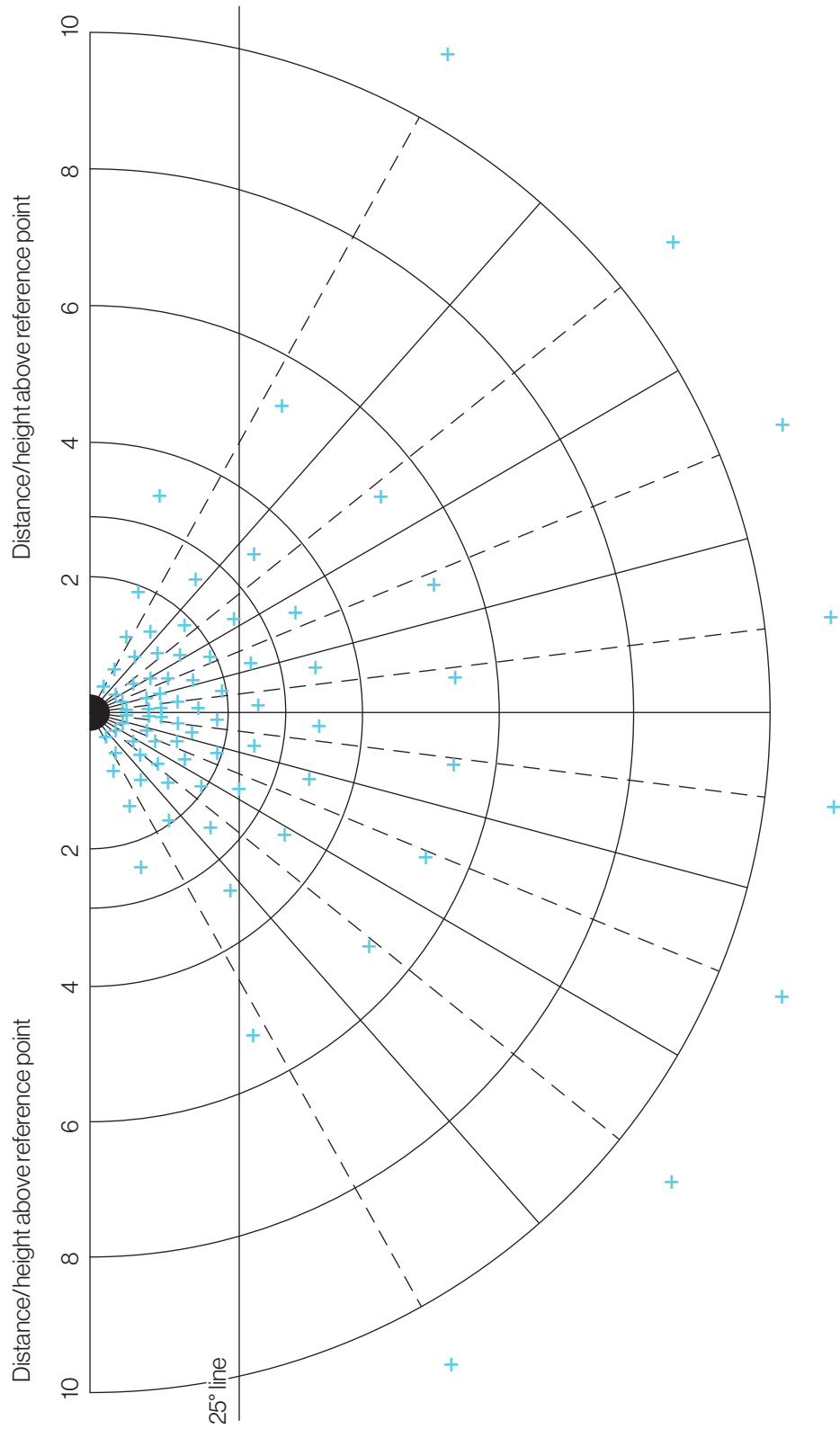

Figure A1: Skylight indicator

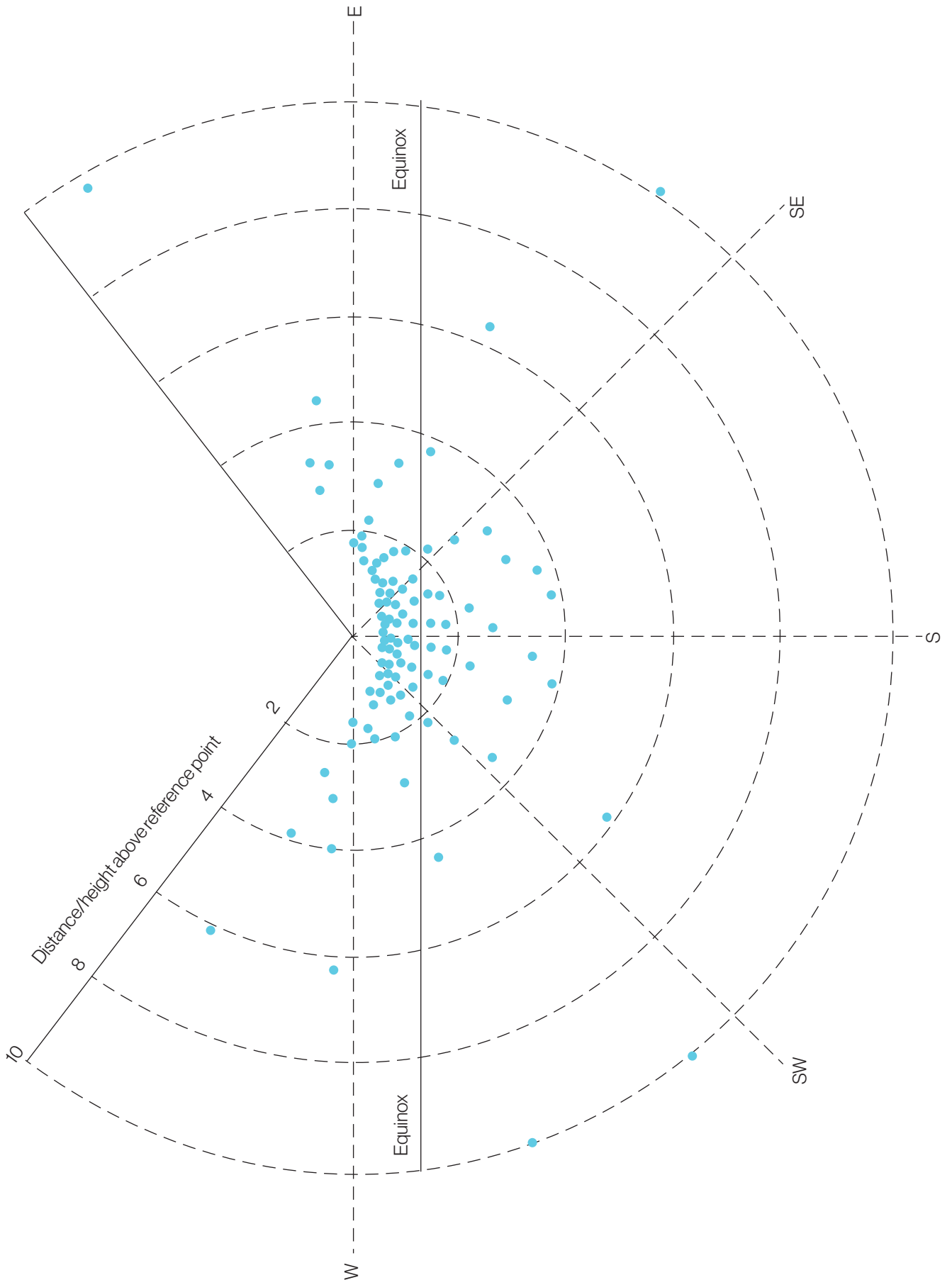

Figure A2: Sunlight availability indicator for London (51.5°N). The annual unobstructed total is 1486 hours.

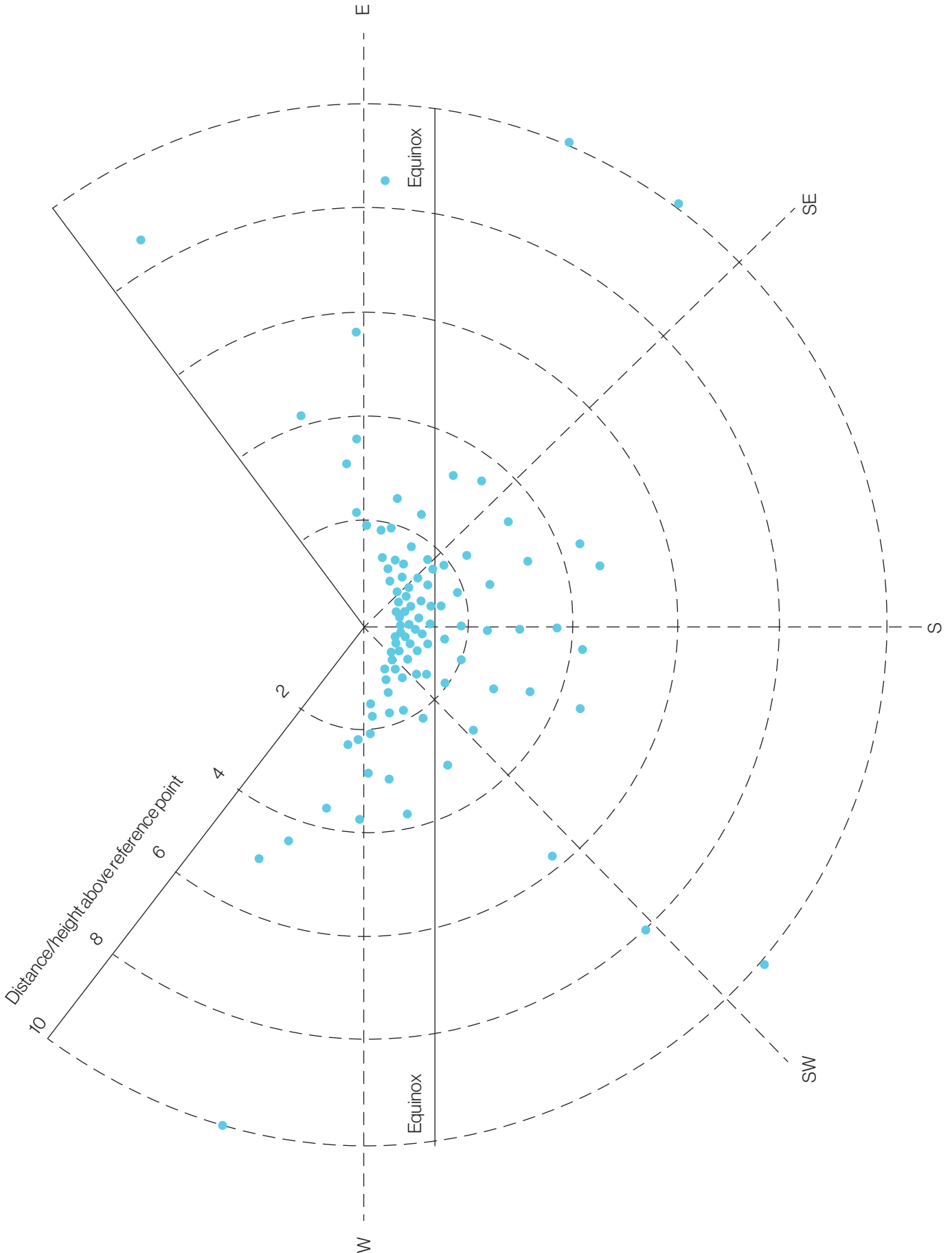

Figure A3: Sunlight availability indicator for Manchester (53.5°N). The annual unobstructed total is 1392 hours.

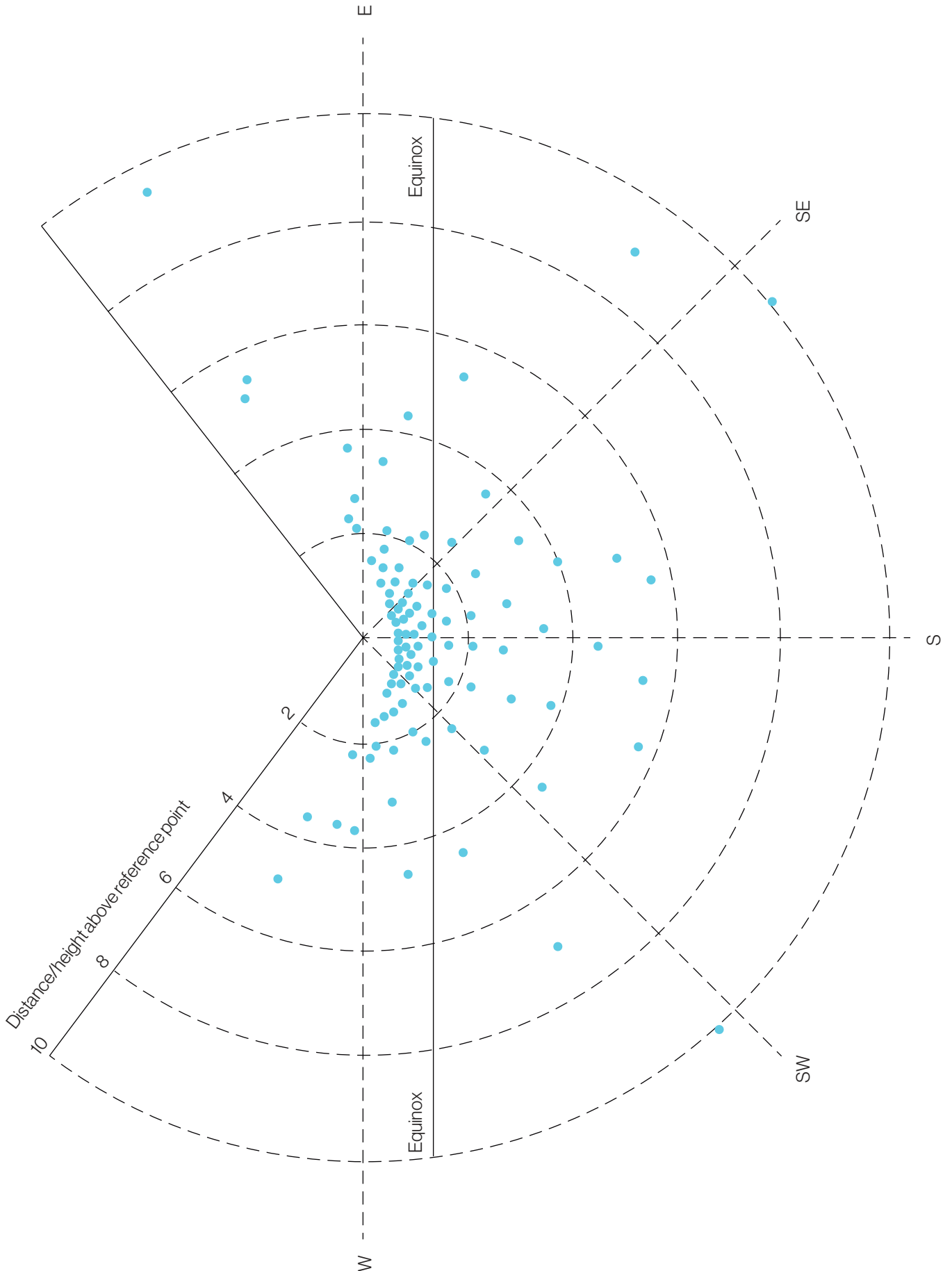

Figure A4: Sunlight availability indicator for Edinburgh/Glasgow (56°N). The annual unobstructed total is 1267 hours.

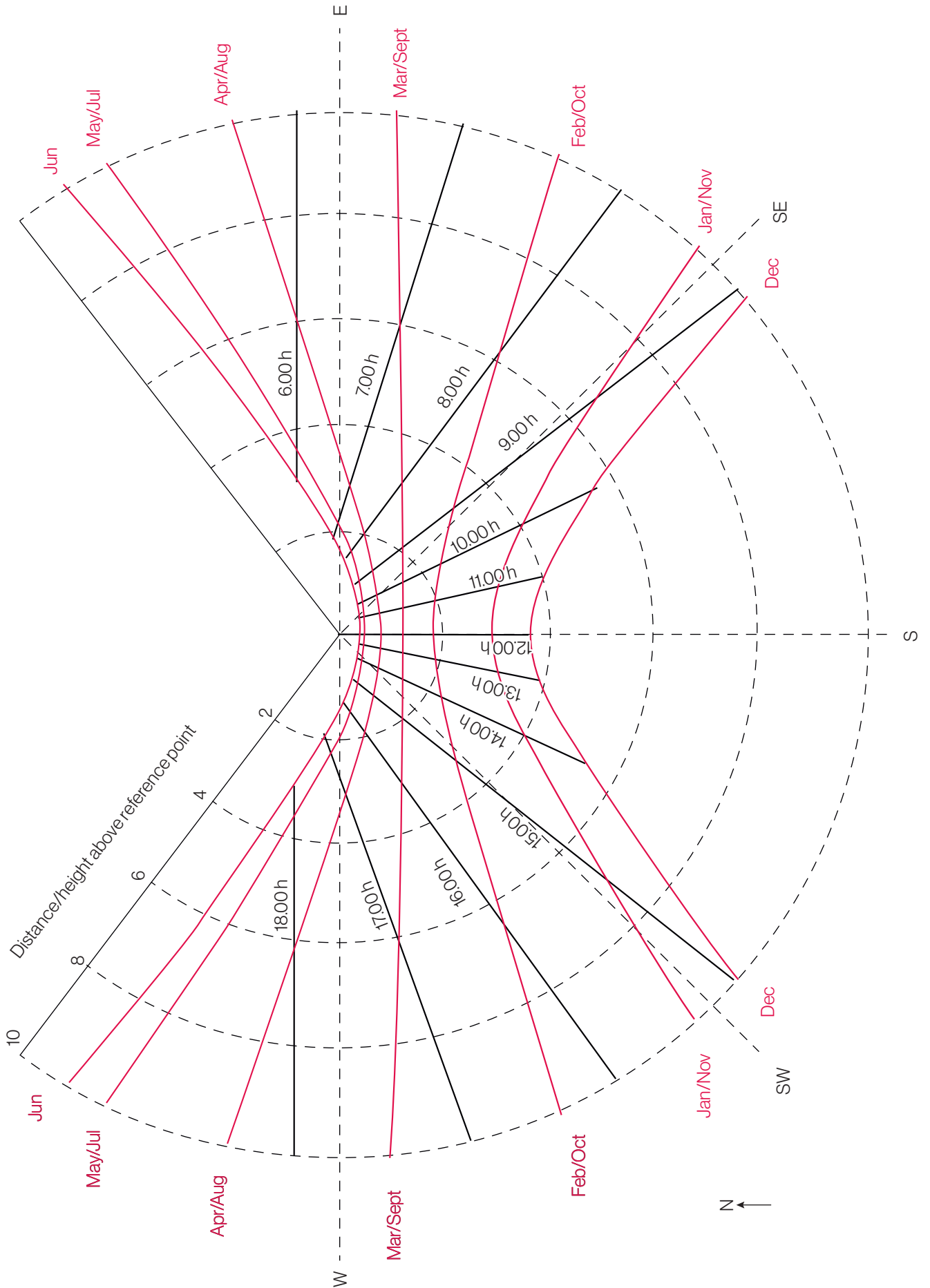

Figure A5: Sunpath indicator for London (51.5°N)

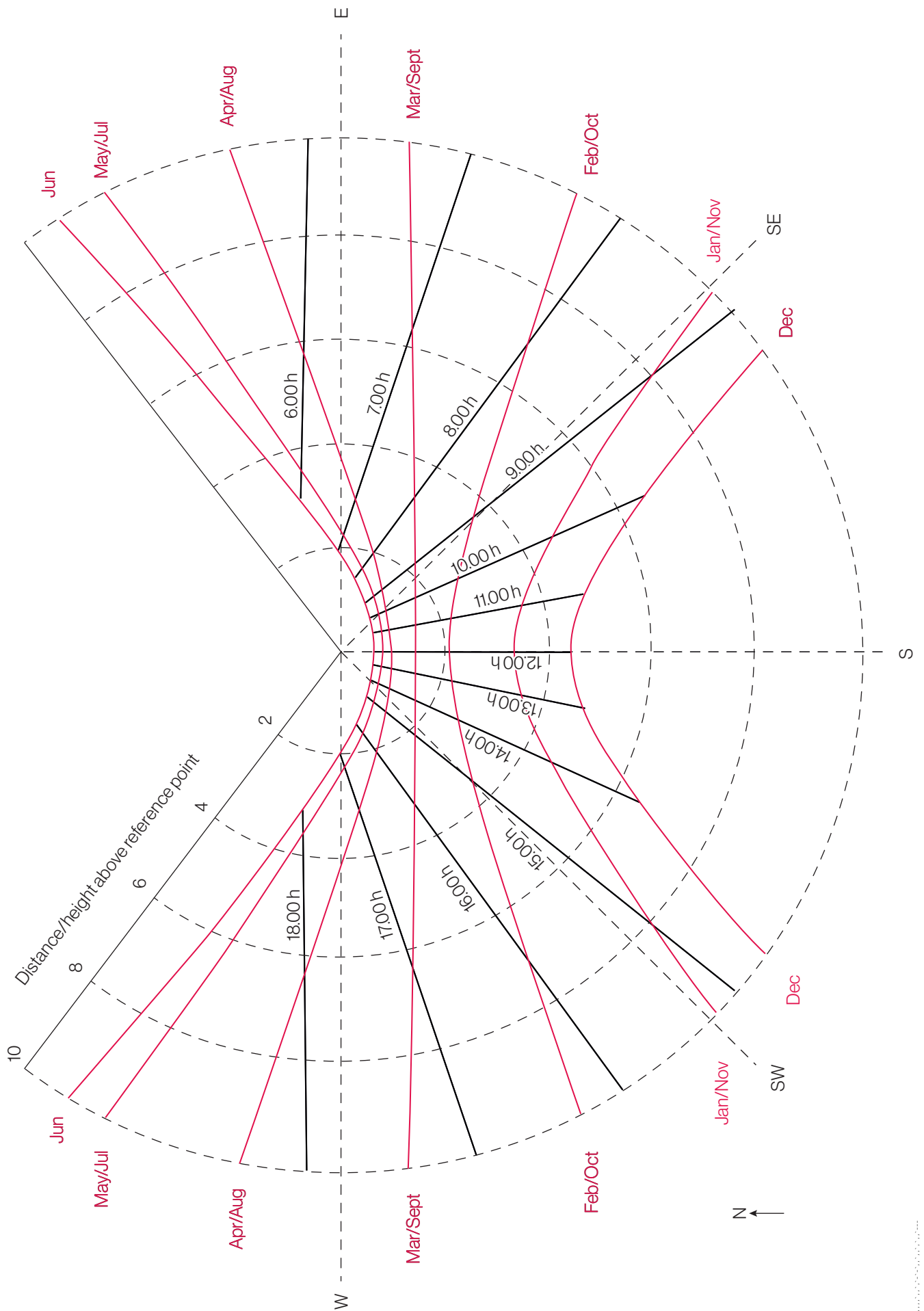

Figure A6: Sunpath indicator for Manchester (53.5°N)



Figure A7: Sunpath indicator for Edinburgh/Glasgow (56°N)

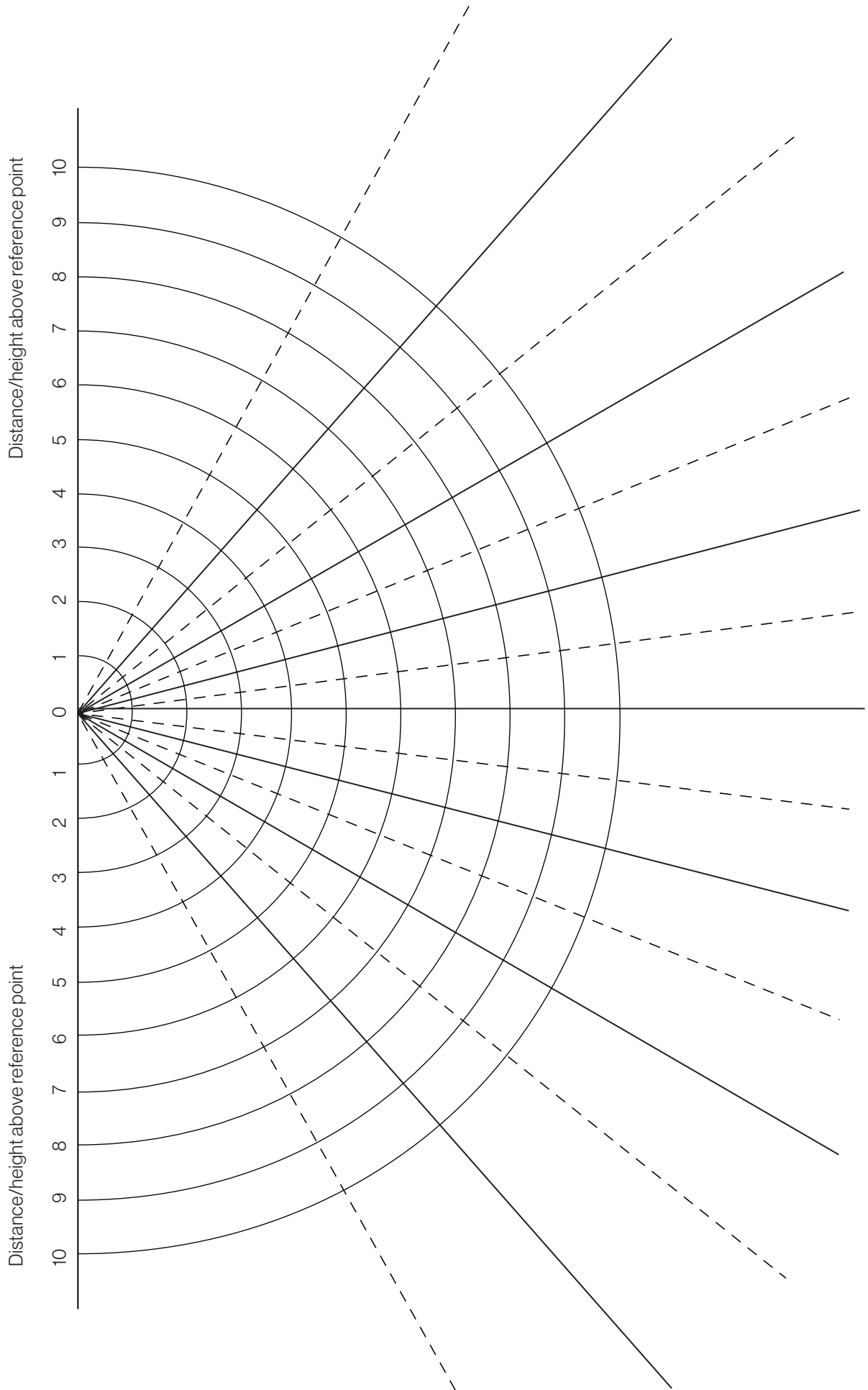

Figure A8: Direction finder for use with the indicators

A1.9 The direction finder is placed on the site plan (of whatever scale). Its centre should be at the reference point and its base parallel to the wall. The direction finder is divided into eight radial zones.

A1.10 To plot an obstruction such as a wall, take each end of the obstruction in turn. Measure its distance in metres from the reference point. Calculate the difference in height between the top of the obstruction and the reference point. Then divide the distance away by the height difference to obtain the ratio (distance of obstruction):(height above reference point). Plot a point on the direction finder in the direction of the corner of the obstruction, and at a distance on the radial scale equal to the ratio calculated above. On an acetate printout, a washable overhead protector pen can be used to make the marks. It is important to realise that the position of the obstruction on the plan will NOT usually coincide with its position on the scale of the direction indicator, although its direction will.

A1.11 Repeat this for the other end of the obstruction and join the two points plotted by a straight line. If the top of the obstruction is level, then the straight line should be parallel to the line of the obstruction on plan. This will not be the case for a sloping obstruction.

A1.12 For both ends of the obstruction, draw lines from the points plotted to the edge of the direction finder, in the direction away from the centre of the direction finder. Shade the area within the shape created.

A1.13 This process is then repeated for every obstruction visible from the reference point. If a house is visible it will usually be necessary to divide it into a series of obstructing elements, e.g. the eaves, line from eaves to ridge, top ridge, line down to other end of the eaves, and the side of the house if it is visible. Each element is then plotted in turn.

A1.14 Figure A9 gives a plan of an example housing layout. It is required to find the daylight and sunlight reaching point O on the plan. The layout is marked on the direction finder as shown in Figure A10. The base of the direction finder is laid parallel to face POQ. Each obstruction is then considered in turn.

A1.15 A proposed extension QRS is plotted as follows. Only the line QR need be plotted as this is the only face of the extension that can be seen from point O. Point Q is 5 m from O, and 5 m above it. This is

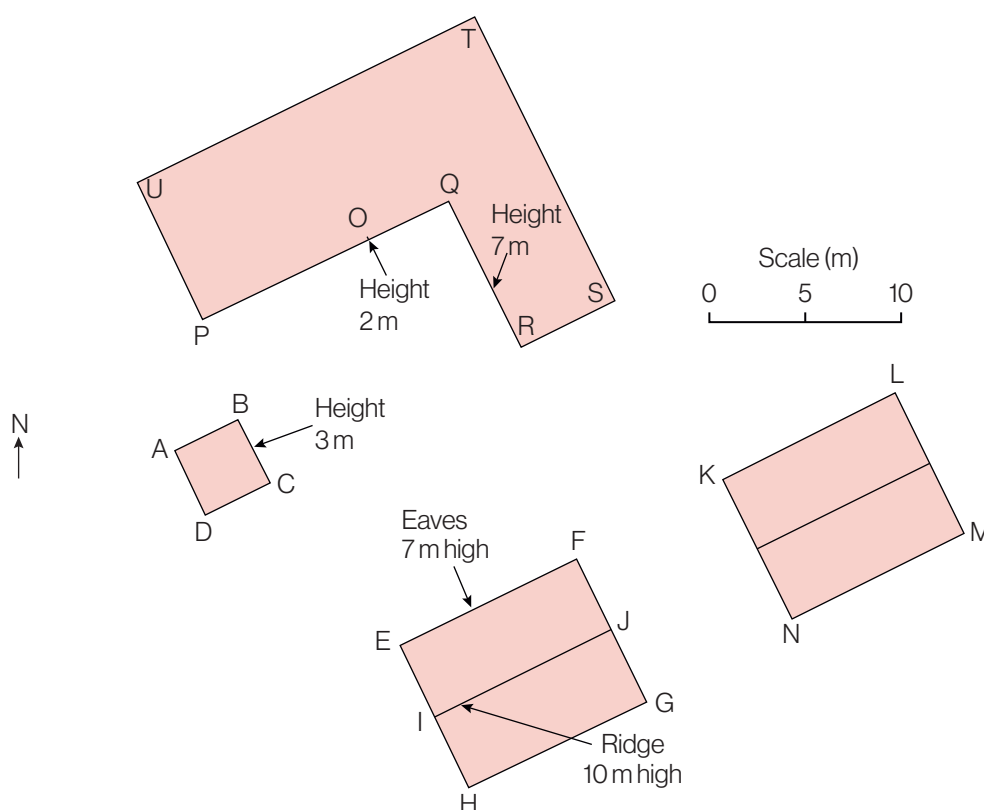

Figure A9: Site plan of an example situation: housing layout

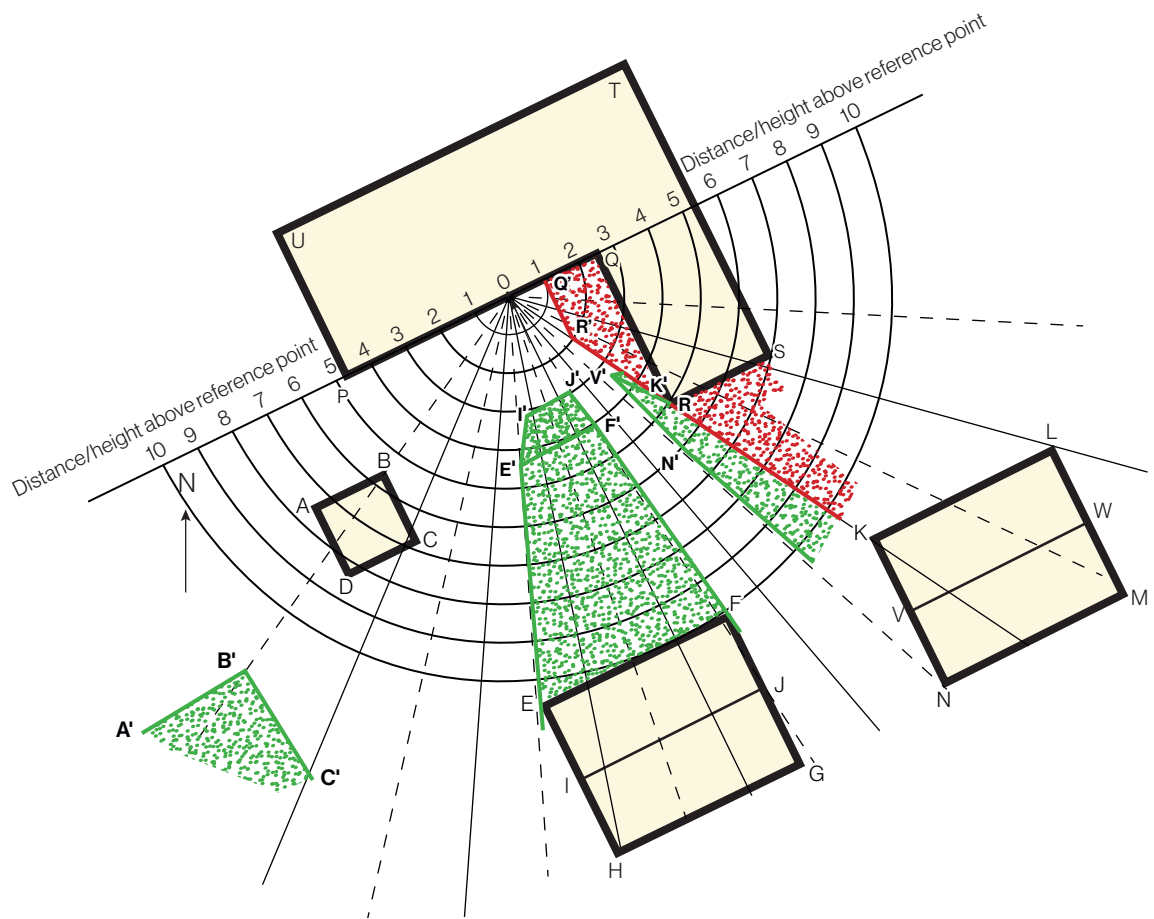

Figure A10: Housing example situation shown in Figure A9 plotted onto the direction finder

a distance to height ratio of 1. This end of the extension is therefore plotted at point Q' on the direction finder, at a distance of one unit from the centre, along the line (in this case the wall of the building) towards Q. The other end of the extension, point R, is 10 m on plan from O and 5 m above it. So R' is marked where the radial line OR intersects the distance: height arc of 2 (10 divided by 5). Points Q' and R' are then joined together. Note that the horizontal extension plotted on the direction finder is parallel to the line of the extension on the original plan.

A1.16 A line is then drawn from the end of the plotted extension R' to the edge of the direction finder, along the radial line from the centre of the direction finder. The area to the right of this line is shaded; these shaded areas represent areas of the sky that the extension will block. In this case the new development has been plotted in a different colour (red) to the existing buildings (green). This is to facilitate the calculation of daylight and sunlight with and without the new development.

A1.17 EFGH is a house with a pitched roof. In this case, both the eaves and the ridge are plotted. Point E is 21.5 m from O and 5 m above it. So the distance/height ratio is $21.5 \div 5 = 4.3$. Point E' on the direction finder is therefore plotted 4.3 units from the centre, along the radial line towards point E. Point F' is plotted in a similar way, and the two are joined together to give the line of the eaves as an obstruction on the direction finder.

A1.18 However in this case the ridge also forms an effective obstruction, because the house is far enough away so that its roof can be seen from point O. Line I'J' is the line of the ridge plotted on the direction finder. It forms an additional obstruction. The lines E'I' and F'J' are also drawn; these correspond to the sloping edges of the roof. All the area behind the lines E'I', I'J', and J'F' is shaded; this represents the sky blocked by the house.

A1.19 House KLMN is plotted in a similar way, except that the side of the house KN has to be plotted, because it will be visible from O. The nearest point on shed ABCD, point B, is 12 m from O and it is 1 m above point O. So its distance to height ratio is 12. This is actually off the scale of the direction finder, thus this shed is unlikely to be a significant obstruction to daylight. In general, obstructions whose distance is more than 10 times their relative height can be ignored.

A1.20 The resulting plot of the obstructions can then be used with the indicators as described below. For use with the sunpath and sunlight availability indicators, the south point of the layout should be marked on the direction finder.

Use of a plan drawn to a specific scale

A1.21 If there is only one obstruction, or if all the obstructions are the same height above the reference point, it is usually easier not to use the direction finder but to draw a special plan. The plan is drawn on tracing paper, or photocopied onto acetate, so that it can be laid over the indicators.

A1.22 It is essential to draw the plan to the correct scale. The scale to be used will depend on the height of the obstruction above the reference point for the calculation. If this distance is h m then the plan should be drawn to a scale of $1:100 h$. Table A1 gives scales for some obstruction heights.

A1.23 Figure A11 illustrates a site plan of an example situation for a courtyard layout. It is a plan of a residential block 10 m high. The block has a central, three sided courtyard. The daylight and sunlight reaching point O, 2 m above ground on the west side of the courtyard need to be found.

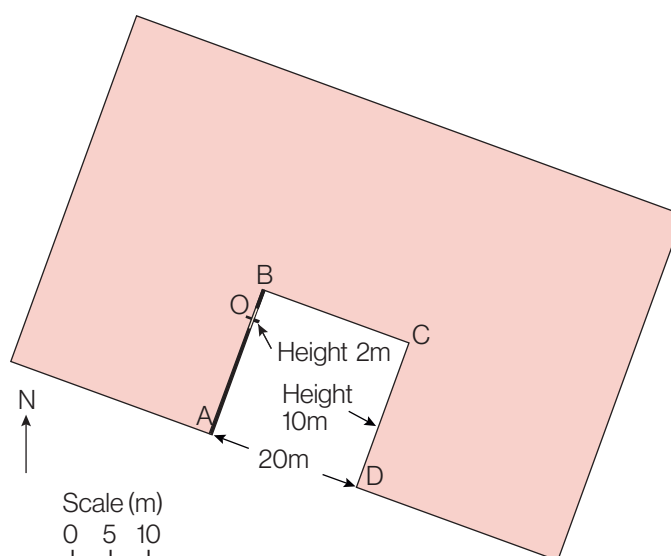

Figure A11: Site plan of an example situation; courtyard layout

Table A1 – Scales of plan for use directly with indicators	
Height of obstruction above reference point (m)	Scale of plan
1	1:100
2	1:200
3	1:300
4	1:400
5	1:500
6	1:600
7	1:700
8	1:800
9	1:900
10	1:1000
15	1:1500
20	1:2000

A1.24 The top of the courtyard is 8 m above point O. So the plan of the building needs to be redrawn to a scale 1:800 (Figure A12). The width of the courtyard (20 m) will be 25 mm in this scale.

A1.25 If the daylight and sunlight are required on a vertical façade (in this case BOA), the line of the façade should be drawn in (it does not matter if it is a different height to the obstructions). For sunlight calculations a south point should also be included. Finally, mark out those areas of the plan from which point O is prevented from receiving light. This is done by drawing radial lines outwards from O from each end of the obstruction. In this case there is just one such line, line DE. Areas to the right of line DE cannot be seen from O. Then the plan can be laid over the indicators as follows.

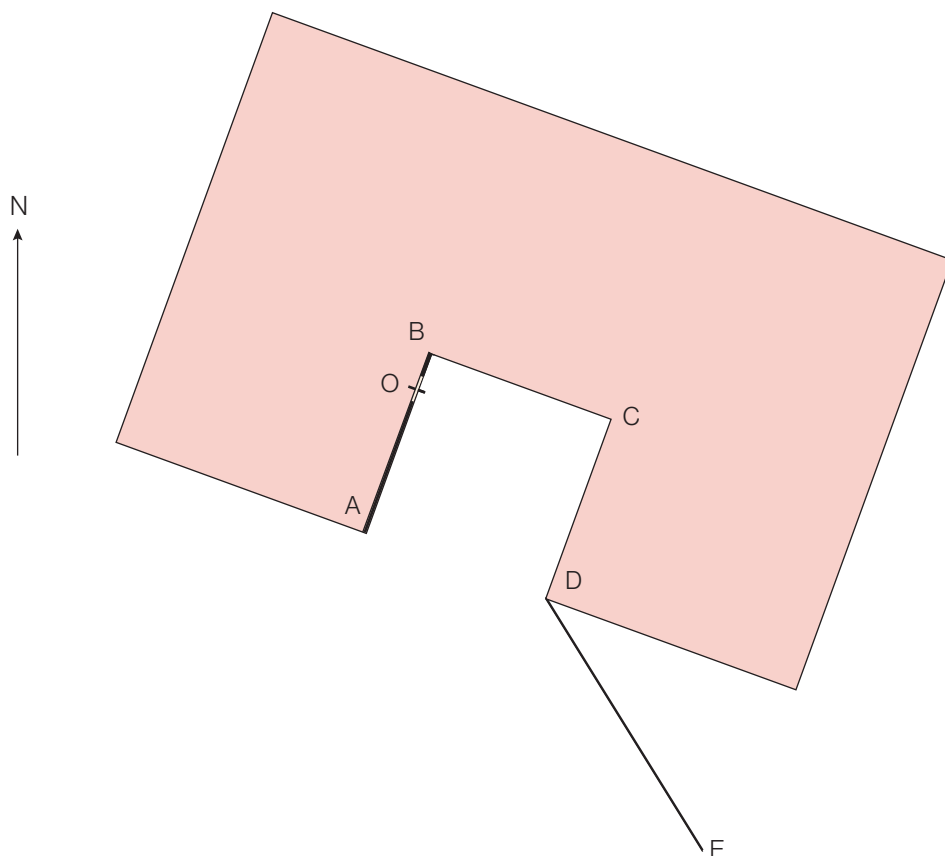

Figure A12: Site plan of Figure A11 redrawn for use with the indicators

A2 Use of the skylight indicator

A2.1 To use the skylight indicator (Figure A1), take the marked direction finder or specially prepared plan and lay it over the indicator. The centre of the indicator should correspond to the reference point, with its base parallel to the line of the vertical plane.

A2.2 The skylight indicator has 80 crosses marked on it. Each of these corresponds to 0.5% VSC. If a cross lies nearer to the centre of the indicator than any obstruction in that direction (as marked on the direction finder or special site plan) then it is unobstructed and counts towards the total VSC. If it lies beyond the obstruction then it will be obstructed and does not count. The VSC at the reference point (in %) is found by counting up the number of unobstructed crosses and dividing by two. If a cross lies on the edge of a plotted obstruction, half a cross (0.25%) can be counted.

A2.3 Figure A13 shows how VSC is found in the housing layout example (Figure A9). The marked direction finder (Figure A10) is laid over the skylight indicator. For clarity, some of the numbers and semi circles on the direction finder have been omitted. The shaded areas lie beyond the obstructions and therefore crosses in these areas do not count. That leaves 62 crosses in the unshaded areas that will contribute to the skylight at point O; a VSC of just over 31%.

A2.4 In Figure A14 the courtyard layout (Figure A11) is analysed. The specially drawn site plan (Figure A12), on tracing paper, is laid over the skylight indicator. Here the number of unobstructed crosses is 47, so the VSC is 23.5%. Note that crosses in the shaded area to the right of line DE do not count as these areas of sky would be blocked by face DC.

A2.5 Counting up the crosses can be speeded up in various ways:

- If a point is lightly obstructed then count up the obstructed crosses, divide by two and subtract this from 40% (the value for an unobstructed vertical plane) to give the VSC. In the housing layout example, existing obstructions (plotted in green on Figure A13), block 8 crosses. The vertical sky component for the existing situation would be $40\% - 8/2 = 40\% - 4\% = 36\%$.
- Each of the eight radial zones contains 10 crosses. So if a zone is completely unobstructed it will contribute 5% to the VSC.
- To check whether the VSC exceeds 27% (the value for a long straight obstruction subtending 25° on section), the 25° line can be used. If the number of obstructed crosses above the 25° line (between it and the reference point) is less than the number of unobstructed crosses below this line then the

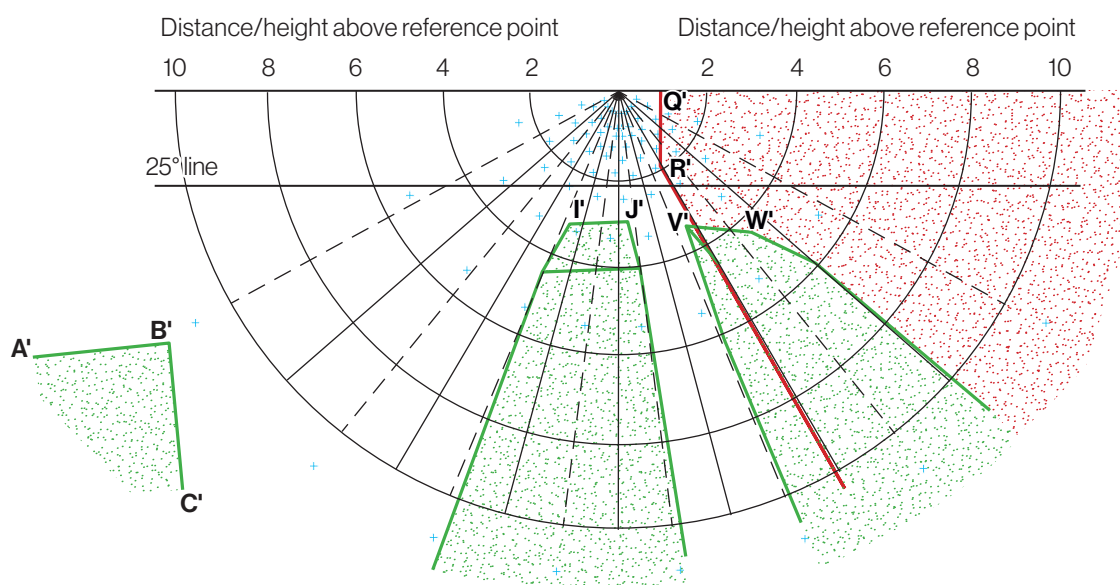

Figure A13: Direction finder plot of housing layout (Figures A9 and A10) laid over skylight indicator

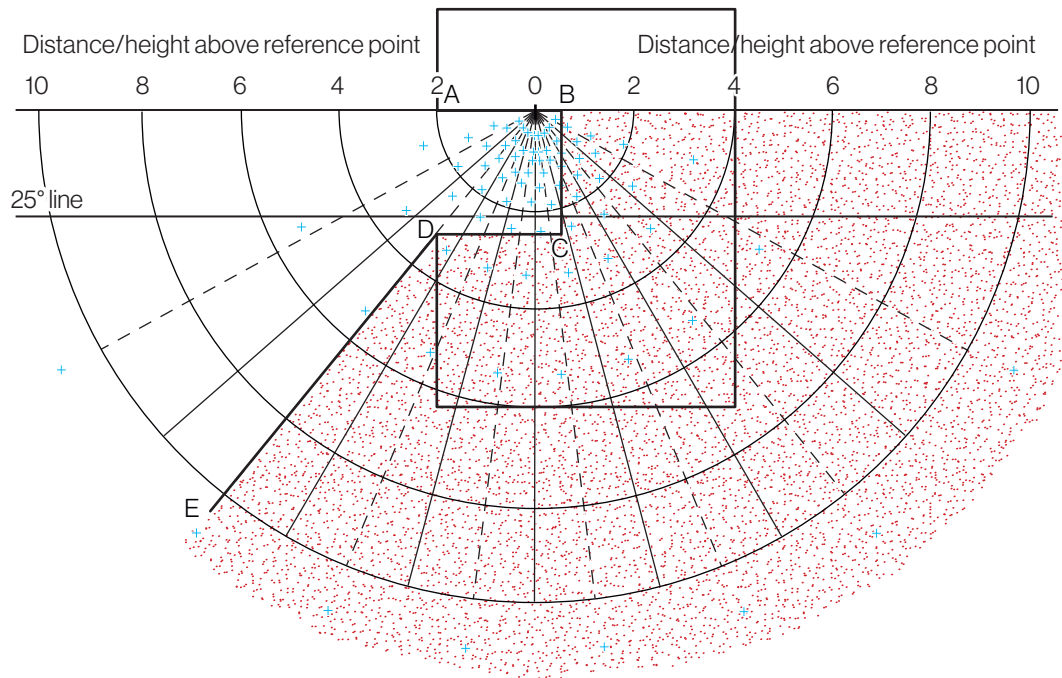

Figure A14: Special site plan (Figure A12) of courtyard layout laid over skylight indicator

27% value is exceeded. In Figure A14 there are 13 obstructed crosses above the 25° line, and only six unobstructed crosses below it. So the courtyard layout has a VSC of less than 27%.

A3 Use of the sunlight availability indicators

A3.1 To estimate sunlight availability, first choose the indicator (Figures A2 to A4) which corresponds best to the latitude of the site (see Appendix A1). Indicators for latitudes further north or south are given in a separate BRE report *Calculating access to skylight, sunlight and solar radiation on obstructed urban sites in Europe*^{A11}. Take the marked direction finder or specially prepared plan and lay it over the indicator, with its centre at the reference point. However, this time the south point on the indicator should be parallel to the south point marked on the direction finder or site plan, regardless of which way the building faces. This is an important difference from the skylight indicator.

A3.2 The sunlight availability indicator has 100 spots on it. Each of these represents 1% of annual probable sunlight hours (APSH). The effects of obstructions are found in the same way as for the skylight indicator. If a spot lies nearer to the centre of the indicator than any obstruction in that direction (as marked on the direction finder or special site plan) then it is unobstructed. The percentage of APSH at the reference point is found by counting up all the unobstructed spots. The numerical total of annual sunlight hours is found by multiplying this fraction by the annual total hours for an unobstructed plane, given in the caption to the indicator (Figures A2, A3, and A4).

A3.3 For existing buildings (see section 3.2), it is recommended that at least 25% of APSH be available at the reference point, including at least 5% of APSH in the six months between 21 September and 21 March (in winter). To check this, use the horizontal equinox line on the indicator. At least 25 spots should be unobstructed, with five or more of them below the equinox line. If the calculation point is on a wall of a building, then sunlight from behind the building cannot of course reach it. So any spots on the building side of the wall on which the reference point lies will be obstructed.

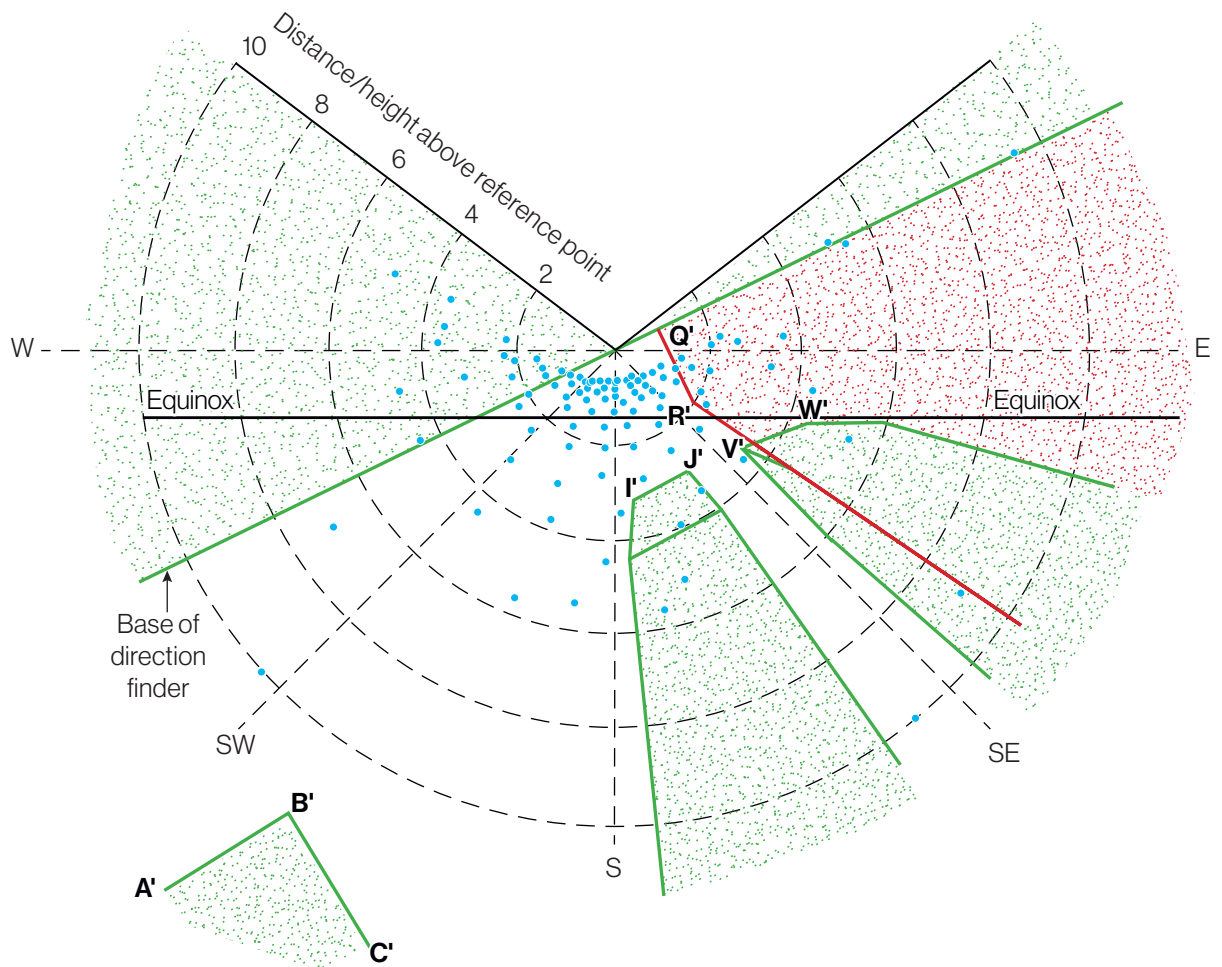

Figure A15: Direction finder plot of housing layout (Figures A9 and A10) laid over sunlight availability indicator

A3.4 Figure A15 shows this indicator being used for the housing layout in Figure A9. The marked direction finder (Figure A10) is laid over the indicator (in this example, for Edinburgh/Glasgow 56°N shown in Figure A4). Its south direction, taken originally from the site plan, is parallel to the south point on the indicator. For clarity, the markings and semi-circles on the direction finder are not shown. The shaded areas would be blocked by the obstructions. Note that areas above the direction finder base are also shaded because sunlight from these directions would be blocked by the building on which point O lies.

A3.5 From Figure A15, the total percentage of APSH reaching point O is 64%, of which 24% are in the six winter months. Thus point O easily meets the recommendation. The total probable sunlight hours reaching O is 64% of 1267, or 811 hours per year.

A3.6 In Figure A16 the courtyard layout (Figure A11) is assessed. The specially drawn site plan (Figure A12) is laid over the indicator, with the two south directions, on plan and indicator, parallel. Note that wall BOA has been continued to A' because sunlight from areas to the north west of AA' will not be able to reach point O. Similarly sunlight from north east of line DE will be prevented by wall CD from reaching point O. The total sunlight availability at O is 46% of annual probable hours, 16% of these being in the winter months. Thus the recommendation is satisfied here too.

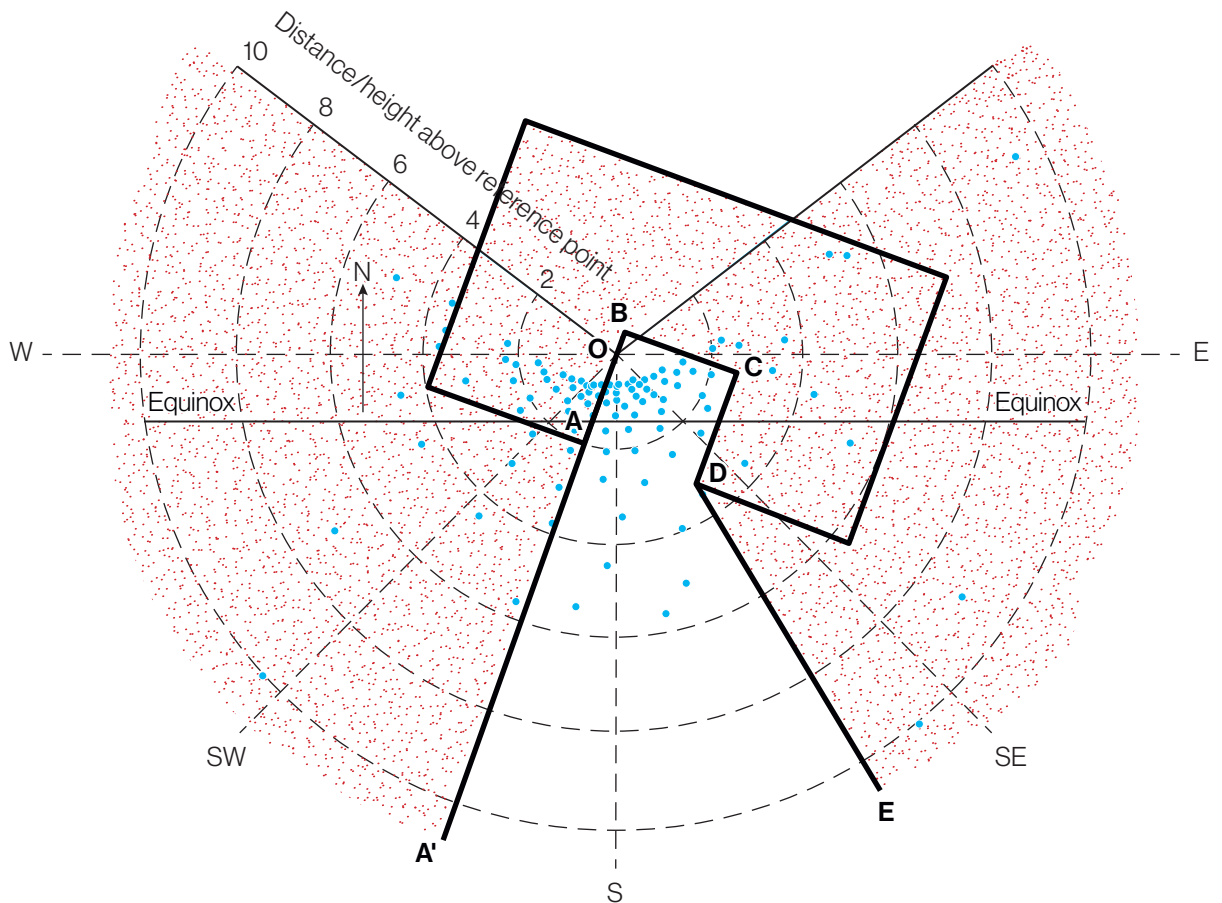

Figure A16: Special site plan (Figure A12) of courtyard layout laid over sunlight availability indicator

A4 Use of the sunpath indicators

A4.1 The sunpath indicators (Figures A5 to A7) give the times of day and year at which sunlight can reach a reference point. The bold curved lines which run across the indicator are sunpaths for the 21st of each month (the months are labelled around the perimeter). Each sunpath is divided into hours by the thinner straight solid hour lines which radiate outwards. These are labelled with solar time which is almost the same as GMT (add one hour for BST). Where the time of day is unusually important, solar time can be corrected using the method described in the BRE report *Availability of daylight*^(A2).

A4.2 The sunpath indicator is used in the same basic way as the sunlight availability indicator. Figure A17 shows the housing layout plot (Figure A10) superimposed on the Edinburgh/Glasgow sunpath indicator (Figure A7). For April/August, May/July and June sunlight will be available at point O from around 08.30 GMT, when the sun appears above wall QR, until just after 15.00, when it goes round past point P in Figure A9. This corresponds to 09.30 until 16.00 BST. In February/October, and March/September there is sun from 09.00 GMT until 16.00. In January/November there is sun for a brief period around 09.30. From 09.40 to 11.40 building IJ blocks it, then from 11.40 onwards the sun is unobstructed until it sets. In December there is sun from 11.40 until sunset.

A4.3 The sunpath indicator can also be used to check whether new developments meet the recommendations for sunlight hours in new buildings in the British Standard, BS EN 17037 (see paragraph 3.1.10 in this guide). In this case, as paragraph 3.1.12 explains, the sunlight hours are calculated on the inside face of the window wall, so sun blocked by the window reveals is excluded. Figure A18 shows the sunpath indicator with the special plan of the courtyard layout (Figure A12). In April/August, May/July and June sunlight is available from around 07.30 GMT, when the sun appears over wall BC, until just 12.15 when it no longer can reach the inside centre of the window. In March/September there is sun from 08.50 GMT until 12.20, and in February/October from 09.55 until 12.20. In January/November and December there is sun from 09.45, when it appears around end D of wall CD, until 12.20.

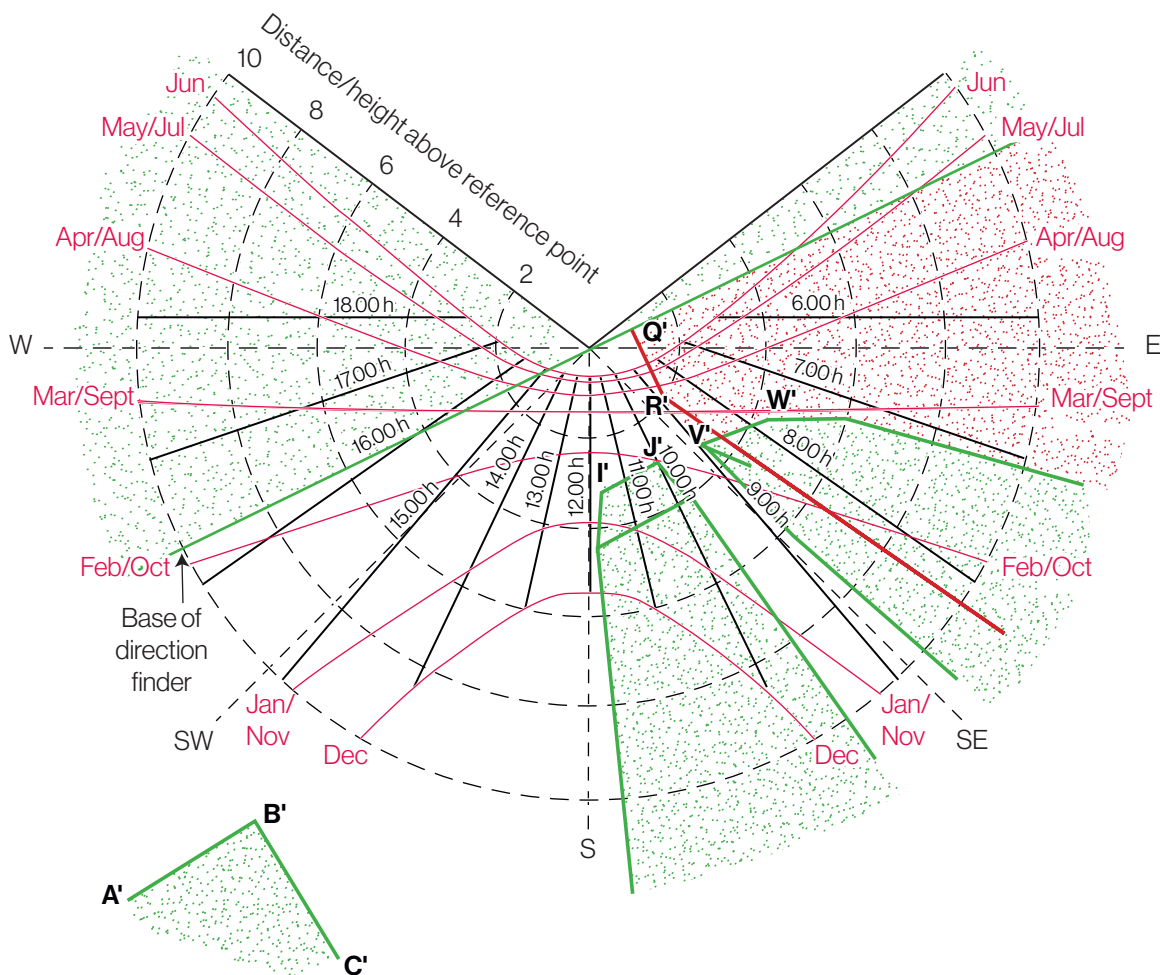

Figure A17: Direction finder plot of housing layout (Figures A9 and A10) laid over sunpath indicator

A4.4 The sunpath indicator can also be used to determine whether a point in a garden or open space can receive two hours of sunlight on March 21. Figure A19 illustrates an example garden. As a first check for a simple space like a rectangular garden, the centre of the garden can be taken.

A4.5 For an L shaped garden, the location of the centre is worked out in the following way. Calculate the total area of the garden. The distance x in Figure G1 is equal to the garden area divided by twice its length (L). The distance y in figure G1 is the garden area divided by twice its width (W). For example, suppose L is 20 m and W is 8 m, and the extension is 8 m long by 4 m wide. The total area of the garden is $20 \times 8 - 8 \times 4 = 128 \text{ m}^2$. The distance x is $128 / (2 \times 20) = 3.2 \text{ m}$. The distance y is $128 / (2 \times 8) = 8 \text{ m}$. So the centre of the garden P is 8 m from the far end of it, and 3.2 m from the side opposite the extension.

A4.6 The centre of the direction finder (Figure A20) is placed at the reference point on the plan where the sunlight needs to be calculated. The base of the direction finder can be aligned in any convenient direction, but it is best to orient it so that only obstructions to the south fall within the semi-circular rings on the direction finder. Obstructions are then plotted in the normal way, with each end of the obstruction being a distance d/h from the centre of the direction finder, where d is the distance of the obstruction on plan and h its height above ground. Figure A20 shows the resulting outline of the obstructions.

A4.7 The marked up direction finder is now laid over the sunpath indicator with its north point facing upwards on the indicator, as shown in Figure A21. The garden is located in southern England, so the London indicator has been used. The hours of sun on March 21 can be established by finding the times at which the 'Mar/Sept' sunpath is unobstructed. This happens from 10.40 until 11.45 and from 14.20 until 15.30. The net result is that point P receives over two hours of sunlight (just over one hour in the morning, and just over one hour in the afternoon).

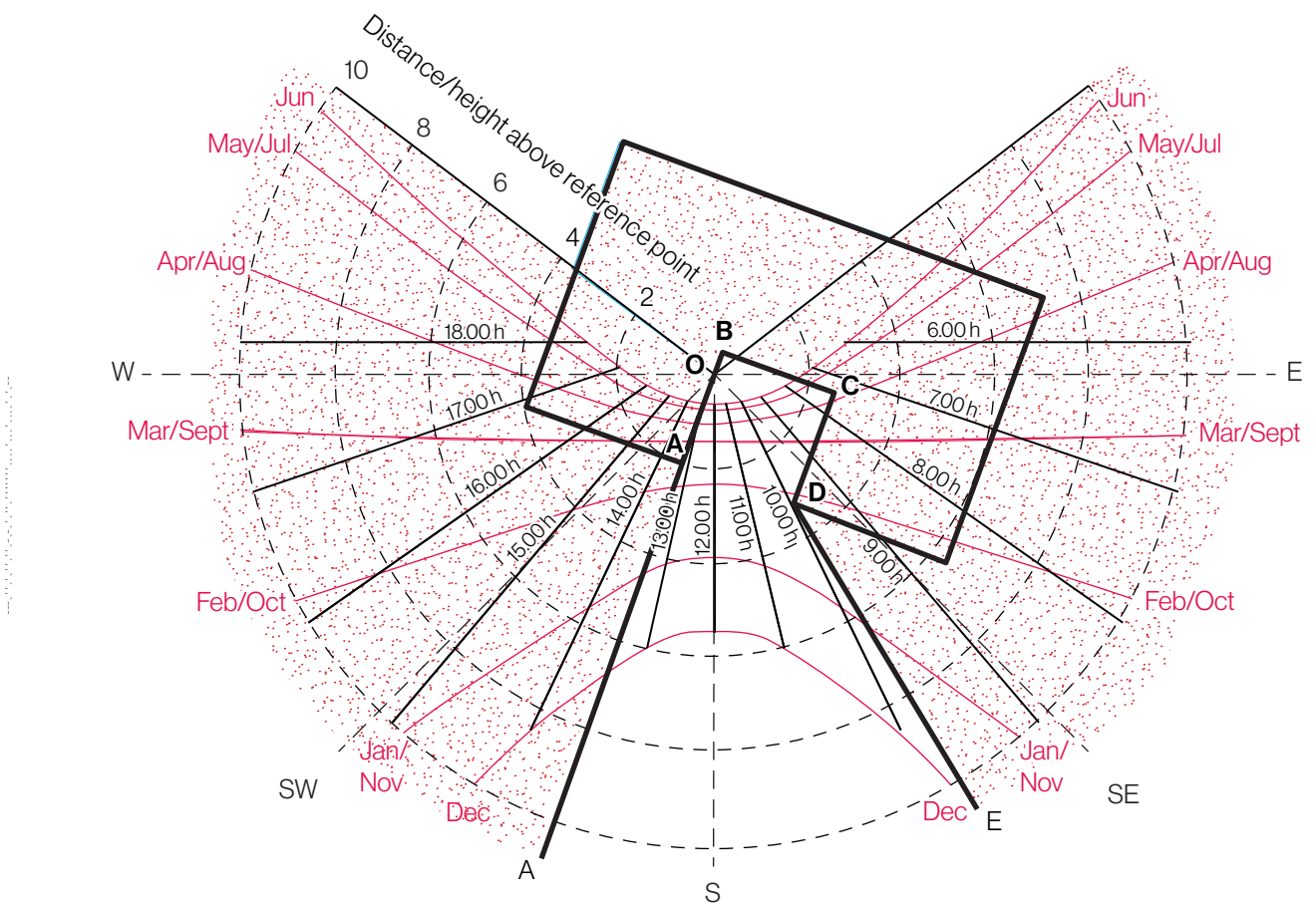

Figure A18: Special site plan (Figure A12) of courtyard layout laid over sunpath indicator

References

- A1 M.E. Aizlewood and P.J. Littlefair. Calculating access to skylight, sunlight and solar radiation on obstructed urban sites in Europe. BRE BR379. Bracknell, IHS BRE Press, 1999.
- A2 DRG Hunt. Availability of daylight. BRE BR21, Bracknell, IHS BRE Press, 1979.

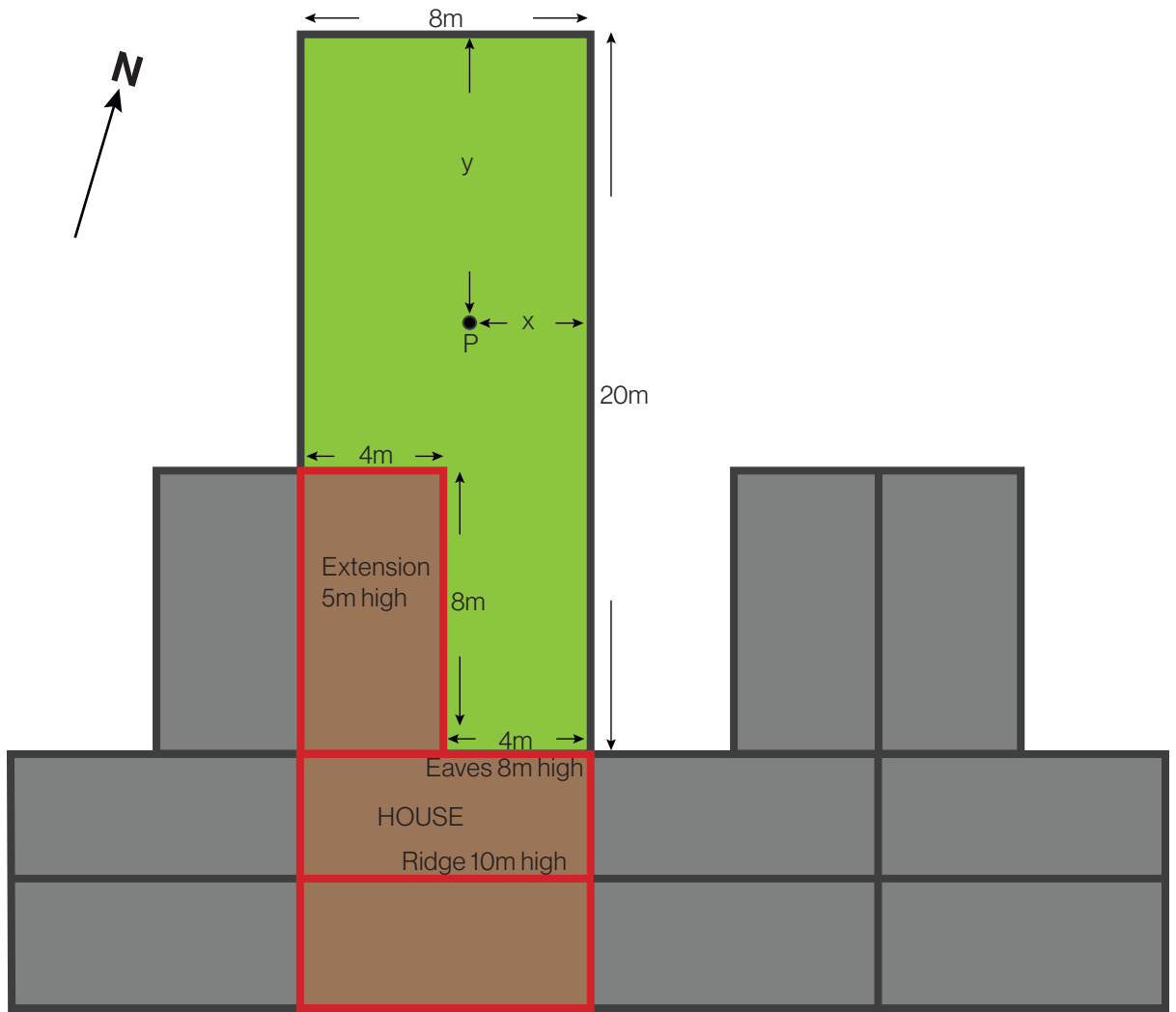

Figure A19: Plan of an example garden showing centre point

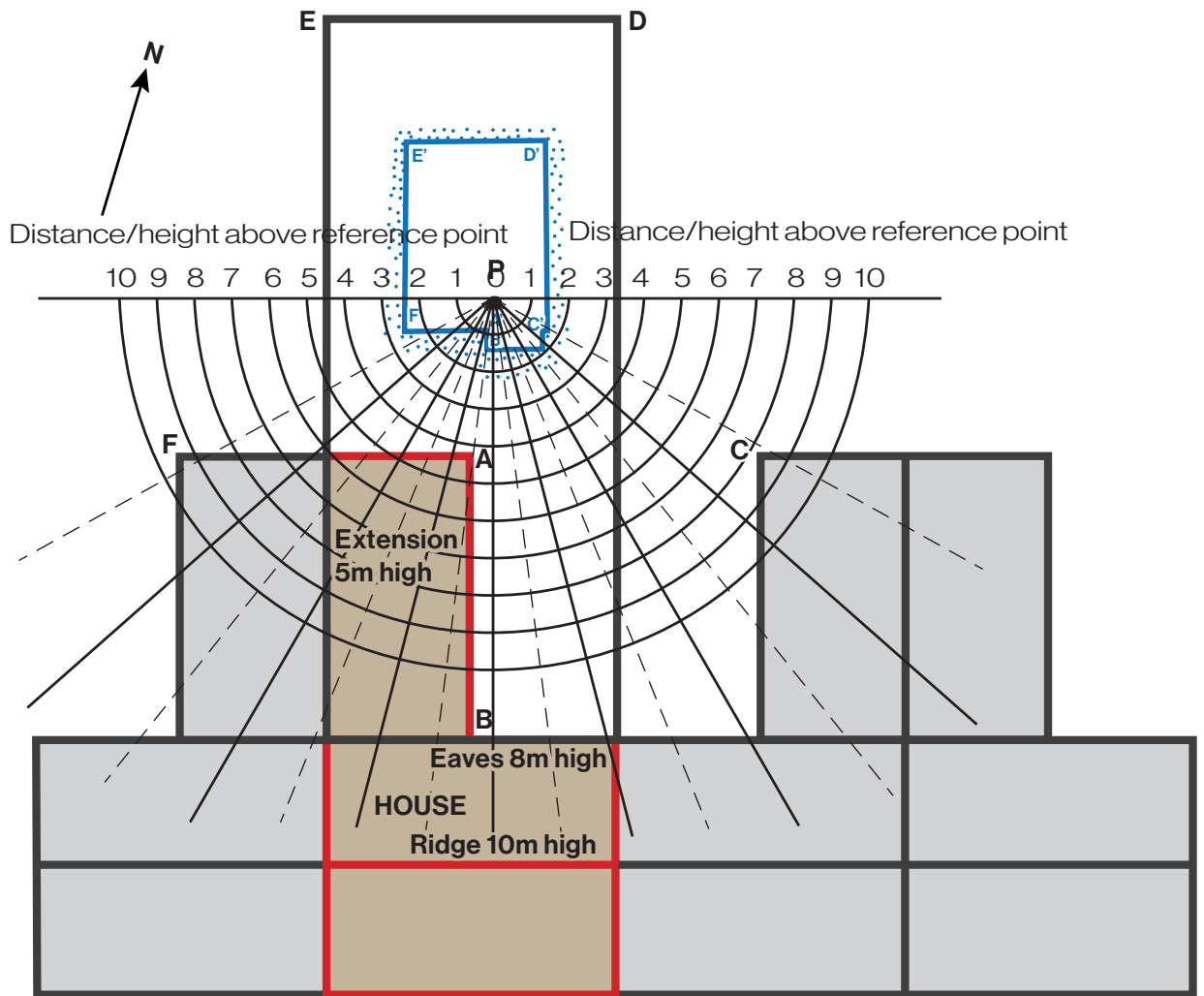

Figure A20: Direction finder superimposed on the example garden

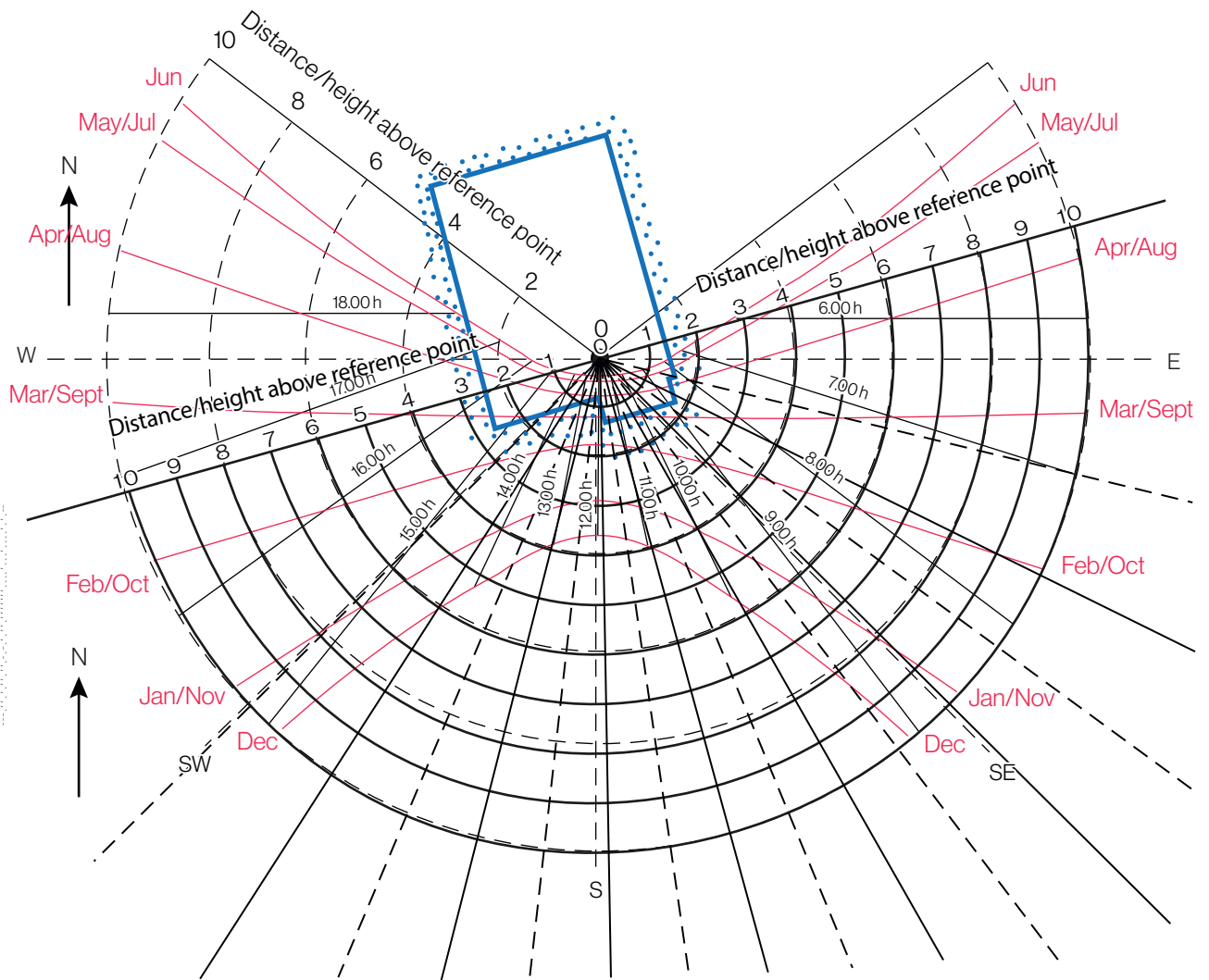

Figure A21: Direction finder plot of obstructions to example garden, laid over sunpath indicator

Appendix B: Waldram diagram to calculate vertical sky component

B1. As an alternative to the skylight indicator described in Appendix A, a special form of Waldram diagram (Figure B1) can be used to estimate the VSC on an external wall or window. Although it will usually be more time consuming to use than the skylight indicator, the Waldram diagram is more precise and may be used for very complex obstructions. The basic approach is to plot all the obstructions on the diagram; the remaining area is proportional to the sky component on the vertical plane.

B2. Figure B1 is used in the same way as the conventional Waldram diagram for interior daylighting, except that no window outline needs to be plotted as only external surfaces are being considered. Each cm^2 on the diagram corresponds to 0.1% sky component. Its total area is just under 400 cm^2 corresponding to the sky component of just under 40% on an unobstructed vertical plane.

B3. The horizontal scale on the Waldram diagram is the azimuth angle in degrees from the line perpendicular to the vertical reference plane. The vertical scale is the altitude angle in degrees above the horizontal measured from the reference point on the vertical plane (usually the centre of the window). On the Waldram diagram, vertical edges of obstructions plot as straight vertical lines; horizontal or sloping edges generally plot as curved lines.

B4. To plot a corner of an obstruction or a point on a sloping edge, first measure the angle on the plan at the reference point between the line to the point on the obstruction and the perpendicular to the window wall. This gives the position on the azimuth scale of the Waldram diagram. The position on the altitude scale is given by:

Altitude angle = $\arctan (h/d)$ degrees

B5. Here h is the height of the point on the obstruction above the reference point, and d is the distance between the two points on plan. In this case, the centre scale of the Waldram diagram should be used, ignoring the droop lines. This altitude angle is not necessarily the same as the angle on any sectional drawing. For example, suppose point B on the roof line of the obstructing building in Figure B2 needs to be plotted; its azimuth angle measured from the plan is 40° . On plan it is 20 m from the reference point P and it is 8 m above it on section. So its altitude angle is $\arctan (8/20) = \arctan (0.4) = 22^\circ$. These two angles give its coordinates on the Waldram diagram (Figure B3).

B6. The droop lines on the Waldram diagram can be used to plot horizontal edges. The solid droop lines are for edges parallel to the plane of the reference point. The droop line is chosen according to the altitude angle of the horizontal edge in a section perpendicular to the reference window wall. So, for example, in Figure B2 the altitude of the ridge line CD is 30° . It is therefore plotted (Figure B3) along the 30° solid droop line, between azimuth angles corresponding to those of C and D on the plan.

B7. The broken droop lines on the Waldram diagram are used to plot horizontal edges perpendicular to the plane of the reference point. The side FG of the roof of the extension in Figure B2 can be plotted in this way. The required droop line can be chosen by finding the coordinates of any point on the obstructing edge using the method described above. Alternatively if an elevation of the wall containing the reference point is available, the angular altitude of the horizontal edge can be measured off it. The correct droop line is the one which intersects the side of the diagram at that point on the altitude scale. In our example, point G has an altitude of 20° measured on the elevation (Figure B2c Elevation). It is plotted at the far edge of the Waldram diagram in figure B3 at 20° on the altitude scale. The broken droop line through this point is the edge of the extension FG.

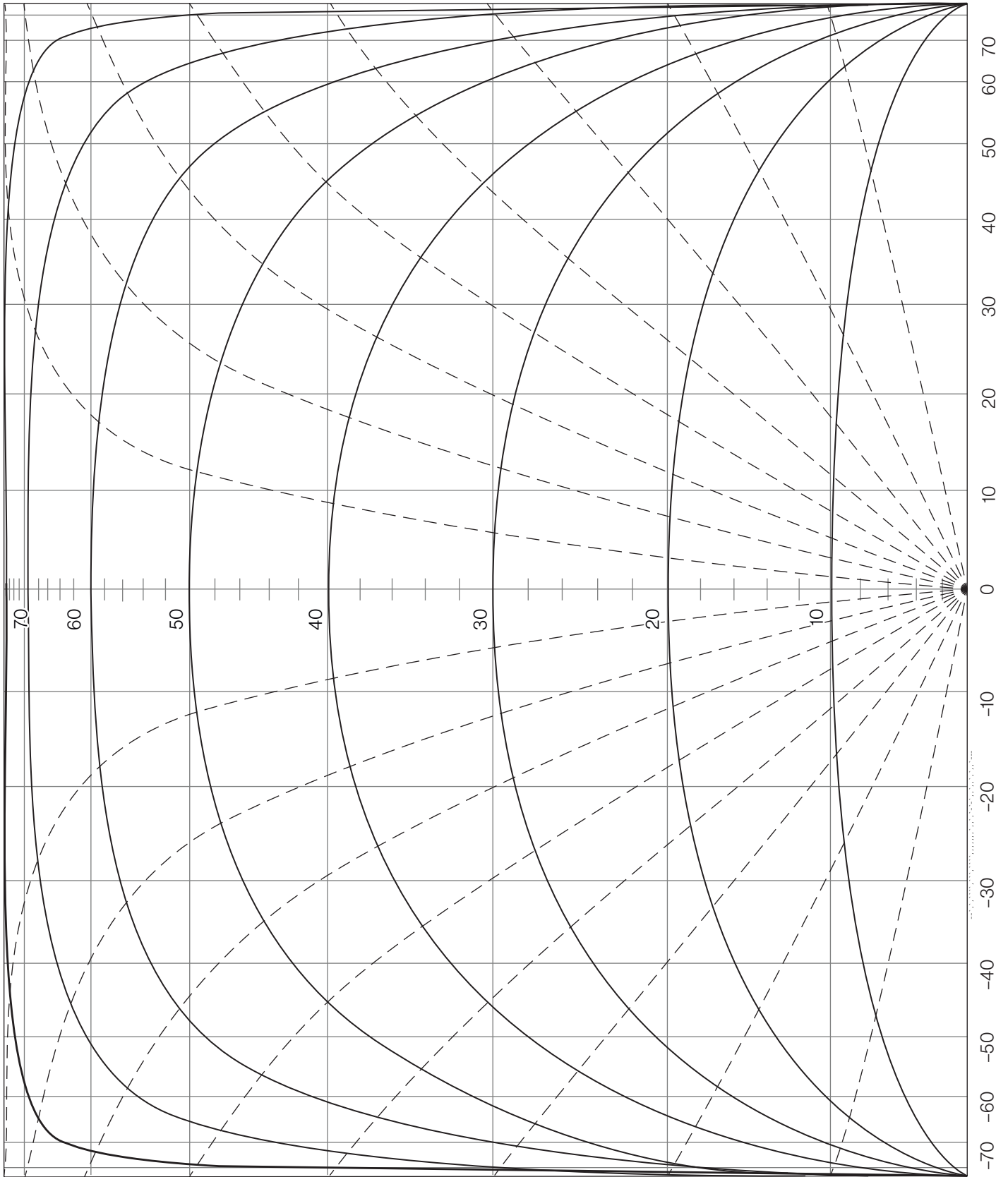
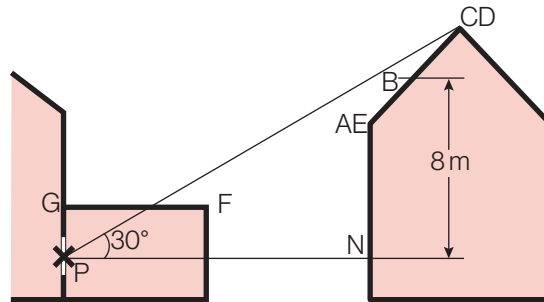
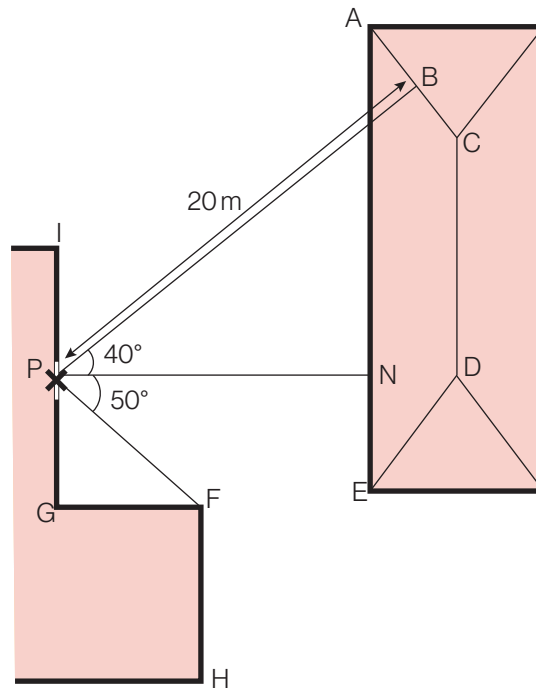

Figure B1: Waldram diagram for calculating VSC

(a) Section



(b) Plan



(c) Elevation

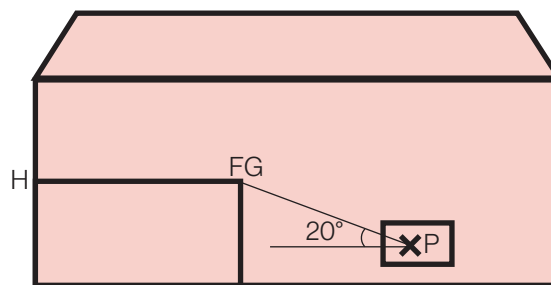

Figure B2: Section, plan and elevation of a (hypothetical) example situation

B8. Once all the obstructions have been plotted, measure the remaining area not covered by obstructions (squared tracing paper is ideal for this). This is then divided by 10 to get the VSC. In our example, the unobstructed area on the diagram (Figure B3) is just over 290 cm². So the VSC is just over 29%.

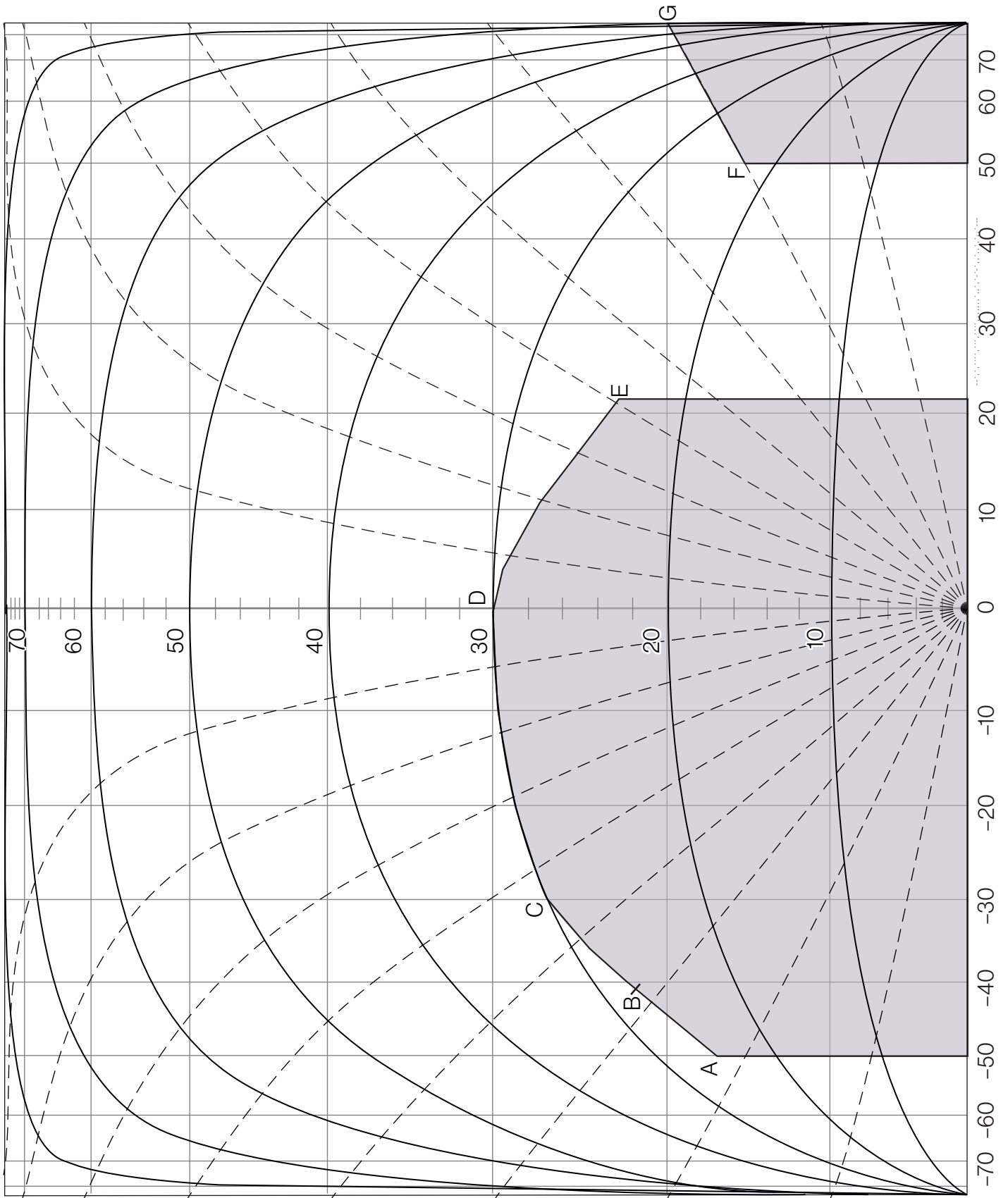

Figure B3: Waldram diagram plot of availability of skylight at point P

Appendix C: Interior daylighting recommendations

C1 The British Standard “Daylight in buildings” (BS EN 17037) contains advice and guidance on interior daylighting. The guidance contained in this publication (BR 209) is intended to be used with BS EN 17037 and its UK National Annex^[C1]. Other European countries have their own versions of EN17037, which do not include the UK National Annex.

C2 BS EN 17037 supersedes BS 8206 Part 2 “Code of practice for daylighting”^[C2], which contained a method of assessment based on Average Daylight Factor, which is now no longer recommended. For daylight provision in buildings, BS EN 17037 provides two methodologies. One is based on target illuminances from daylight to be achieved over specified fractions of the reference plane (a plane at table top height covering the room) for at least half of the daylight hours in a typical year. The other, alternative, method is based on calculating the daylight factors achieved over specified fractions of the reference plane.

C3 BS EN 17037 gives three levels of recommendation for daylight provision in interior spaces: minimum, medium and high. For compliance with the standard, a daylit space should achieve the minimum level of recommendation.

Illuminance method

C4 This method involves using climatic data for the location of the site (via the use of an appropriate, typical or average year, weather file within the software) to calculate the illuminance from daylight at each point on an assessment grid on the reference plane at an at least hourly interval for a typical year.

C5 A target illuminance (E_T) should be achieved across at least half of the reference plane in a daylit space for at least half of the daylight hours. Another target illuminance (E_{TM}) should also be achieved across 95% of the reference plane for at least half of the daylight hours; this is the minimum target illuminance to be achieved towards the back of the room.

C6 Table C1 gives these target illuminances for side lit rooms. Different targets, given in Table A2 of BS EN 17037, apply in spaces with horizontal rooflights^[C1].

Table C1 – Target illuminances from daylight over at least half of the daylight hours		
Level of recommendation	Target illuminance	Target illuminance
	E_T (lx) for half of assessment grid	E_{TM} (lx) for 95% of assessment grid
Minimum	300	100
Medium	500	300
High	750	500

C7 The illuminance method is detailed and calculation intensive. It may take some time to process depending on the software, detail of the calculation model and the available computing power.

Daylight factor method

C8 This method involves the computation of the daylight factor at each calculation point on an assessment grid.

C9 The daylight factor is the illuminance at a point on the reference plane in a space, divided by the illuminance on an unobstructed horizontal surface outdoors. The CIE standard overcast sky^[C3] is used, and the ratio is usually expressed as a percentage.

C10 Since the calculation uses an overcast sky model, the daylight factor is independent of orientation and location. In order to account for different climatic conditions at different locations, BS EN 17037^[C1] gives equivalent daylight factor targets (D) for each capital city in Europe.

C11 For spaces with side windows, equivalent daylight factor targets to achieve a target illuminance over at least half of the daylight hours in a year are based on the formula:

$$D = \text{Target illuminance} / \text{Median external diffuse horizontal illuminance} \times 100 (\%)$$

where the median external diffuse horizontal illuminance ($E_{v,d,med}$) is the illuminance from the sky on an unobstructed horizontal surface achieved for half of the yearly daylight hours at a particular location.

C12 Table C2 gives the daylight factor targets for side lit rooms in London. The National Annex to BS EN 17037^[C1] gives values for other UK locations. Different targets apply in spaces with horizontal rooflights^[C1].

Table C2 – Target daylight factors (D) for London		
Level of recommendation	Target daylight factor D for half of assessment grid	Target daylight factor D for 95% of assessment grid
Minimum	2.1%	0.7%
Medium	3.5%	2.1%
High	5.3%	3.5%

C13 The recommendations for side lit rooms are met if both target daylight factors (the median daylight factor over 50% of the reference plane, and the minimum daylight factor over 95% of the reference plane) are achieved.

C14 The daylight factor method is less computation intensive than the illuminance method, but usually a detailed simulation model is still used, unless point daylight factors are manually calculated^[C4] or measured on site^[C5].

Specific recommendations for daylight provision in UK dwellings

C15 A UK National Annex gives specific minimum recommendations for habitable rooms in dwellings in the United Kingdom. These are intended for 'hard to light' dwellings, for example in basements or with significant external obstructions or with tall trees outside, or for existing buildings being refurbished or converted into dwellings. The National Annex therefore provides the UK guidance on minimum daylight provision in all UK dwellings.

C16 The UK National Annex gives illuminance recommendations of 100 lux in bedrooms, 150 lux in living rooms and 200 lux in kitchens. These are the median illuminances, to be exceeded over at least 50% of the assessment points in the room for at least half of the daylight hours. The recommended levels over 95% of a reference plane need not apply to dwellings in the UK.

C17 Where a room has a shared use, the highest target should apply. For example in a bed sitting room in student accommodation, the value for a living room should be used if students would often spend time in their rooms during the day. Local authorities could use discretion here. For example, the target for a living room could be used for a combined living/dining/kitchen area if the kitchens are not treated as habitable spaces, as it may avoid small separate kitchens in a design. The kitchen space would still need to be included in the assessment area (Figures C4 and C5). Alternatively, in rooms with a particular requirement for daylight, such as bed sitting rooms in homes for the elderly, higher values such as those in tables C1 and C2 may be taken.

C18 The UK National Annex gives the latitude, median external diffuse and global illuminances for various UK locations, as well the daylight factor targets corresponding to the target illuminances as shown in Table C3. The targets for the latitude nearest to the assessment site should be used.

C19 Table C3 shows the daylight factor targets to be achieved over at least 50% of the assessment grid in domestic habitable rooms with vertical and/or inclined daylight apertures. The UK National Annex^[C1] gives alternative target values for rooms with diffusing horizontal rooflights.

Table C3 – Target daylight factors (D_T) to achieve over at least 50% of the assessment grid in UK domestic habitable rooms with vertical and/or inclined daylight apertures			
Location	D_T for 100 lx (Bedroom)	D_T for 150 lx (Living room)	D_T for 200 lx (Kitchen)
St Peter (Jersey)	0.6%	0.9%	1.2%
London (Gatwick Airport)	0.7%	1.1%	1.4%
Birmingham	0.6%	0.9%	1.2%
Hemsby (Norfolk)	0.6%	0.9%	1.3%
Finningley (Yorkshire)	0.7%	1.0%	1.3%
Aughton (Lancashire)	0.7%	1.1%	1.4%
Belfast	0.7%	1.0%	1.4%
Leuchars (Fife)	0.7%	1.1%	1.4%
Oban	0.8%	1.1%	1.5%
Aberdeen	0.7%	1.1%	1.4%

C20 The recommendations are met if the median of the daylight factors calculated in a room meets or exceeds the specific target for room type and location.

Calculation model

C21 The methodologies described above usually require assessment via detailed computer modelling to simulate the illuminance or daylight factor at calculation points within a proposed space. Appropriate simulation settings must be used. The calculation model should include all the room surfaces, and any surface outside the room that could affect the light received.

Surface reflectance

C22 Internal and exterior surfaces and obstructions need to be modelled including appropriate surface reflectances. Fixtures and fittings need not be included. If trees would impact the daylight to the new development, they should be taken into account. Advice on how to do this is given in Appendix G of this document.

C23 Surface reflectances should represent real conditions. Where reflectance values have not been measured or specified, default values to be used in the calculation are given in Table C4.

Table C4 – Recommended default surface reflectances	
Surface	Default reflectance
Interior walls	0.5
Ceilings	0.7
Floors	0.2
Exterior walls and obstructions	0.2
Exterior ground	0.2

C24 Where surface finishes have been specified or measured on site, they can be used in the calculations with appropriate factors for maintenance and furniture. To allow for these factors, maximum reflectances for white painted surfaces in the calculations should not exceed 0.8 indoors, and 0.6 outdoors. Maximum reflectances for light pastel walls should not exceed 0.7 in the calculations, and maximum reflectances for light wood floors should not exceed 0.4. Surface reflectances used should be presented in the assessment, along with a specification of the materials if non-default reflectances are used.

Glazing transmission

C25 Glazing transmission factors, including maintenance factors, need to be included in the simulation along with account for, or modelling of, window framing. Where window frames are not specifically included in the model, frame factors should be applied based on the ratio of glass to overall window aperture area for the type of window to be used; this will generally vary with window size and whether the windows have opening lights. Where window types have not been specified, results for the overall window aperture should be multiplied by a default framing factor as given in Table C5.

Table C5 – Recommended default framing factors	
Window type	Default framing factor
Windows with small panes	0.5
Normal windows with opening lights	0.6
Patio doors	0.7

C26 For clean, clear double glazing with a low emissivity coating, a value of 0.68 for diffuse transmittance can be used. For other types of glazing, the diffuse transmittance, if needed, can be found by multiplying the manufacturer's normal incidence light transmittance by 0.91. Care needs to be taken to apply the correct values within the calculation software; often software programs use the normal incidence transmittance, which is directly available from the glazing manufacturer, and have inbuilt correction for light coming from oblique angles.

C27 An additional maintenance factor also needs to be applied to the glazing transmission to account for dirt on the windows. Full details are given in the National Annex to BS EN 17037. For the more common residential applications, values are given in Table C5. These assume the windows will be regularly cleaned.

Table C6 – Maintenance factors for different types of windows		
Type of window	Maintenance factor	
	Rural/suburban	Urban
Vertical, no overhang	0.96	0.92
Vertical, sheltered from rain, e.g. by balcony or overhang	0.88	0.76
Sloping rooflight	0.92	0.84
Horizontal rooflight	0.88	0.76

Assessment grid

C28 The calculation of illuminance or daylight factor (as described in the methodologies above) needs to be carried out on a grid of points on a reference plane within each room assessed. The plane should normally be 0.85m from the floor level (sometimes described as the working plane height). The standard states that the assessment grid should exclude a band of 0.5m from the walls, unless otherwise specified. In dwellings it is recommended that a band of 0.3m should be excluded, to avoid excluding parts of the room that are used by the occupants. Professional judgement should be used in cases with irregular shaped spaces or rooms with corridor or annex areas.

C29 The standard gives an equation for maximum grid spacing. However, for domestic rooms this can give only nine points in the room. It is therefore recommended to have a maximum grid spacing of 0.3m and preferably less.

Example room layouts

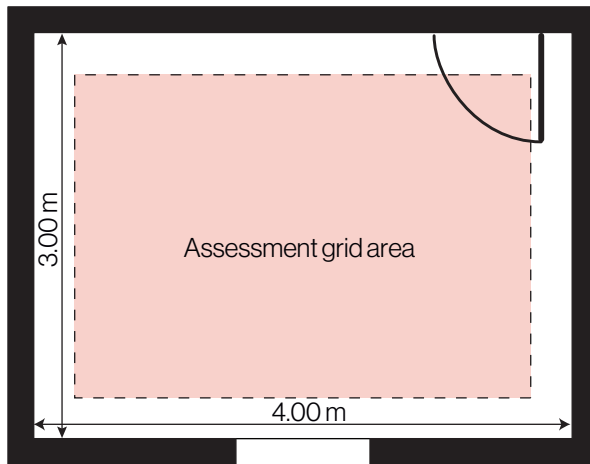

Figure C1: In this example of a regular shaped room, the assessment grid is in the area more than 0.3m from the walls.

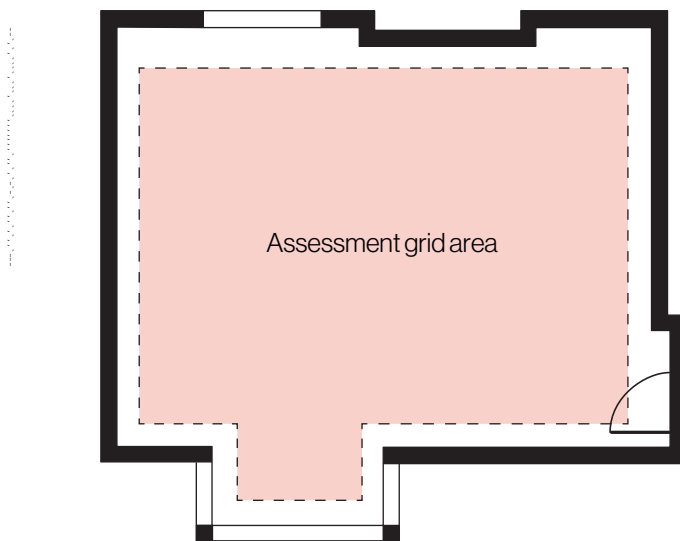

Figure C2: Where room layouts have small variations or alcoves along a wall's length, the inner or dominant section should be taken as a basis for the 0.3m gap to the assessment grid area. Fixed floor to ceiling cupboards can be excluded from the room area, but not kitchen units incorporating a worktop. Areas in bay windows may be included unless they are winter gardens separated from the room by a fixed partition.

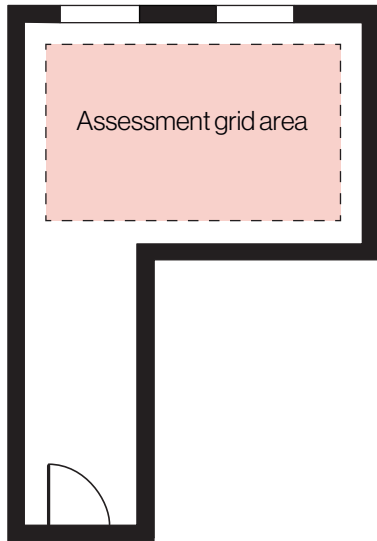

Figure C3: In a room with a corridor, or annexed entrance, the corridor need not be included in the assessment grid area (unless it is wide enough to be part of the usable space in a room, typically over 1.5m wide). The room layout and surfaces, including the corridor would still need to be included in the calculation model.

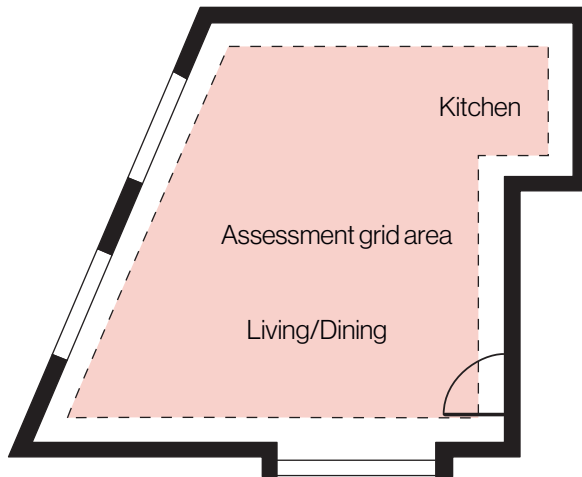

Figure C4: For a combined living/dining/kitchen area, the kitchen should always be included as part of the room area in the calculations, even in cases where the kitchen is deemed non-habitable and the living room criterion is applied to the whole space.

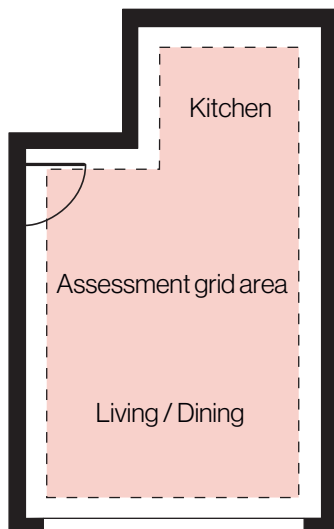

Figure C5: Irregular shaped rooms follow the same principles. Professional judgement on how to place the assessment grid area may be required in complex situations.

C30 Outdoor and semi-conditioned spaces, partitioned from the room, like balconies and wintergardens should not be included in the reference grid, but the effects of balconies and overhangs above a window should be modelled.

Presentation of results

C31 It may not be necessary to analyse every room in a proposed development. For example, if a building has the same room and window layouts on each floor, and rooms on a lower floor meet the recommendations, then the corresponding rooms on upper floors would be expected to meet the recommendations too.

C32 For each room, the median illuminance or median daylight factor (exceeded over 50% of the reference plane) should be presented, as this enables comparison with the different recommendations in BS EN 17037^[C1]. For non-domestic interiors where daylight calculations are undertaken, the minimum illuminance or minimum daylight factor (exceeded over 95% of the reference plane) should also be presented.

C33 As an optional extra, the proportional area of the reference plane exceeding a particular target value may be presented. Contour plots showing illuminances or daylight factors throughout the room may also be presented.

Sunlight

C34 For evaluation of sunlight provision, follow the recommendations outlined in sections 3.1 and 3.2. In assessment of the hours of sunlight to new buildings, a time step of five minutes or less should be used.

References

- C1 BSI. Daylight in buildings. BS EN 17037. London, BSI, 2018.
- C2 BSI. Code of practice for daylighting. BS 8206-2:2008. London, BSI, 2008.
- C3 BSI. Spatial distribution of daylight. CIE standard general sky. BS ISO 15469:2004. London, BSI, 2004.
- C4 BRE. Estimating daylight in buildings. Parts 1 and 2. BRE Digests 309 and 310. Bracknell, IHS BRE Press, 1986.
- C5 Littlefair P.J. Measuring daylight. IP23/93. Bracknell, IHS BRE Press, 1993.

Appendix D: Plotting the no sky line

D1 The no sky line divides those areas of the working plane which can receive direct skylight, from those which cannot. It indicates how good the distribution of daylight is in a room. Areas beyond the no sky line will generally look gloomy.

D2 If the external obstructions already exist, it is possible to measure directly the position of the no sky line in a room. This is best done using a vertical pole such as a small camera tripod, and adjusting its height to that of the working plane. By moving the tripod about, and kneeling or sitting on the floor, and sighting through the top of the tripod to the window head, it is possible to find the exact places at which the last patches of sky disappear (Figure D1). If furniture or walls make this difficult, a small mirror mounted on the top of the tripod can be used as shown in Figure D2. A convex mirror is easiest to use. The mirror need not be exactly horizontal.

D3 In most cases the position of the no sky line has to be found from plans. The calculation can only be carried out where room layouts are known. Using estimated room layouts is likely to give inaccurate results and is not recommended. However where plans are available, for example on the local authority's online planning portal, the calculation should be carried out. Figures D3 to D7 illustrate some common cases. It is usually easiest to have both a plan and section drawn up.

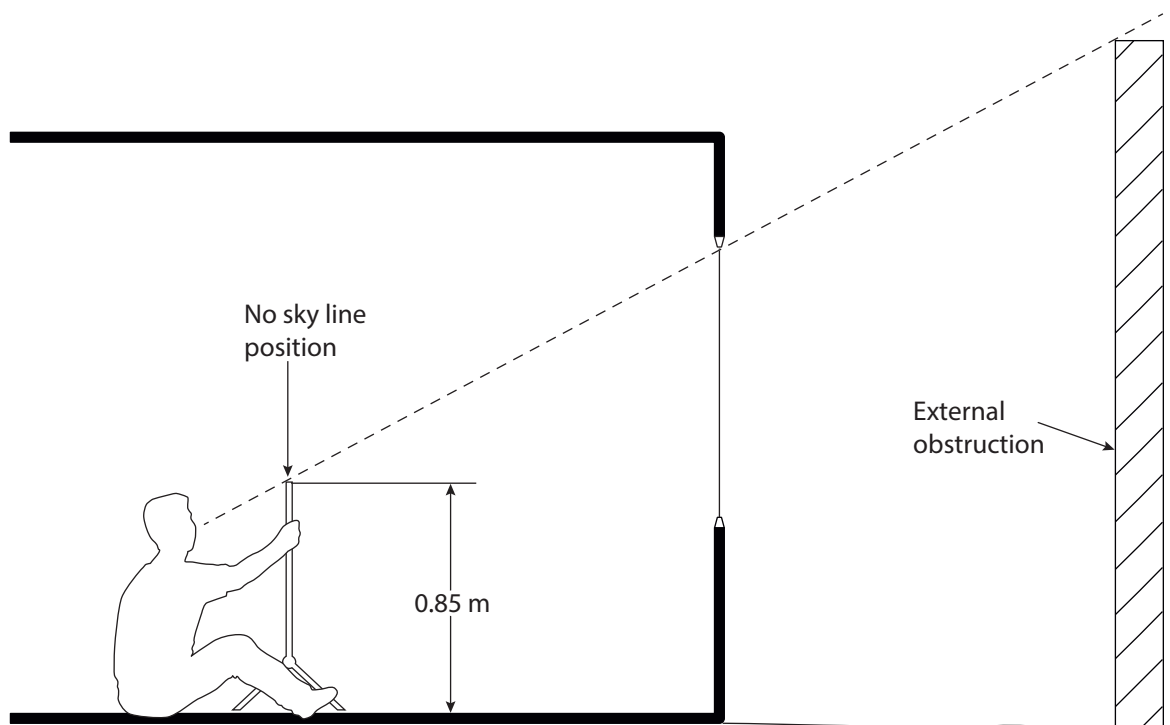

Figure D1: At the no sky line, the last visible patch of sky above the obstructions will just disappear when the window head is sighted through a point at working plane height

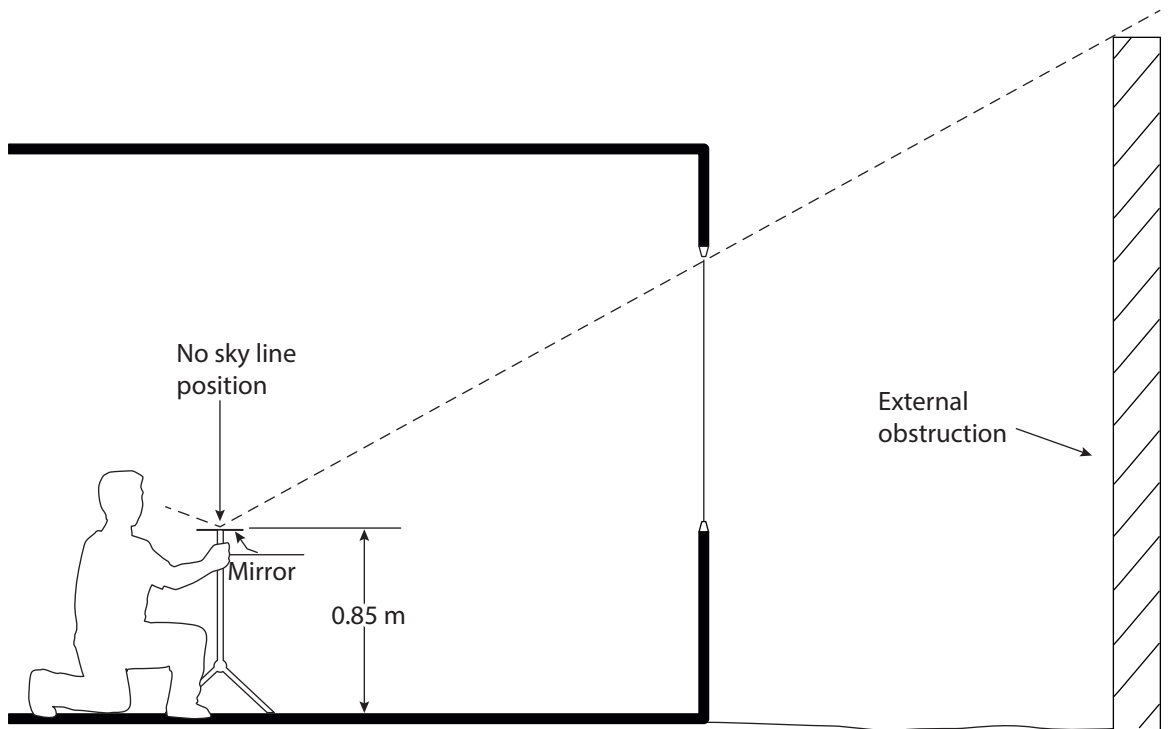

Figure D2: A mirror can be used to sight the no sky line position (compare with Figure D1). A convex mirror is easier to use

Long horizontal obstruction parallel to window (Figure D3)

D4 The no sky line is also parallel to the window, distant:

$$d = x h / y$$

from its outside face.

Here:

h is the height of the window head above the working plane

y is the height of the obstruction above the window head

x its distance from the outside window wall.

D5 If d is greater than the room depth, no part of the room lies beyond the no sky line.

Narrower horizontal obstruction parallel to window (Figure D4)

D6 Here the obstruction is the same height and distance away as in Figure D3, but it terminates at points A and B. CD is part of the same no sky line as in Figure D3, but now points north of DE can receive light around corner A of the obstruction, and points south of CF can receive light around corner B. So the no sky area is in the form of a trapezium. If the obstruction AB had been even narrower, the no sky

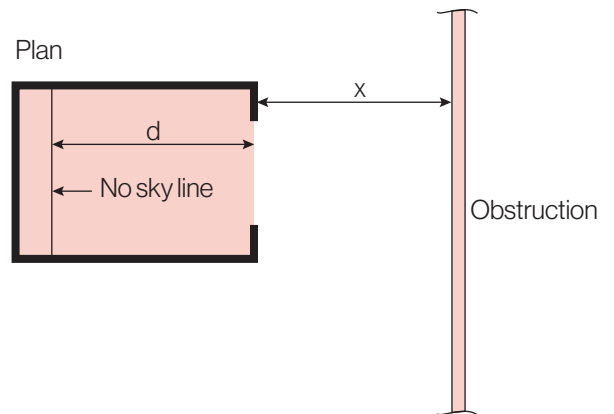
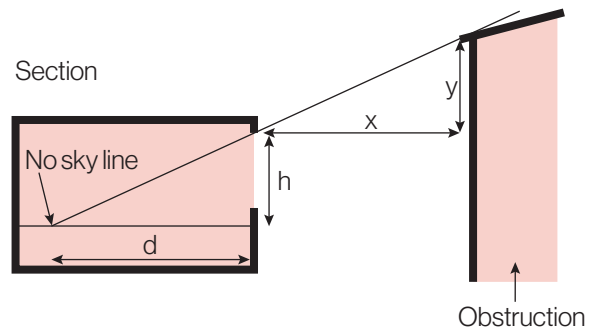

Figure D3: For a long horizontal obstruction parallel to the window, the no sky line is also parallel to the window. Its position can be found from the section.

area would be triangular in shape, and in the same position even if the obstruction was slightly higher.

D7 In plotting the no sky line the key points are the top corners of the window. These are usually the last points at which sky can be seen.

Horizontal obstruction perpendicular to window wall and projecting from it (Figure D5)

D8 Part of the no sky line (DB) runs parallel to the obstruction. Its distance d from the corner of the window A (the corner furthest from the obstruction) is:

$$d = x h / y$$

Here h is the height of the window head above the working plane.

y is the height of the obstruction above the window head.

x is the distance on plan from corner A to the obstruction measured along the window wall.

D9 The rest of the no sky line BC is the continuation of the straight line FABC from the end of the obstruction. Points in the triangle EBC can receive skylight around the corner F; points in the triangle ABD can 'see' sky over the top of the obstruction.

D10 This is a special case of a general rule; if there is a horizontal obstruction at any orientation relative to the window wall, then part of the no sky line will be parallel to the obstruction. Its position is given by:

$$d = x h / y$$

where d and x are the perpendicular distances to the no sky line and the obstruction, measured from the corner of the window furthest from the obstruction (Figure D6).

h is the height of the window head above the working plane

y is the height of the obstruction above the window head.

This applies unless the obstruction is too narrow and sky is visible around its sides.

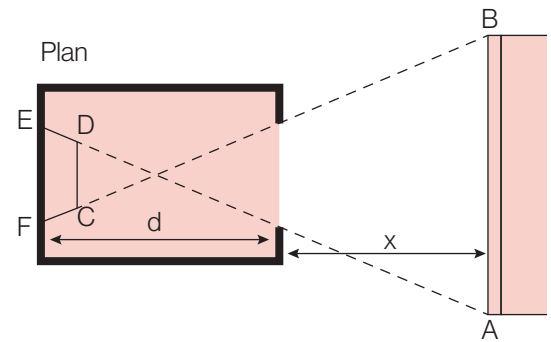

Figure D4: The no sky area for a narrower obstruction is bounded by lines through the centre of the window and the vertical ends of the obstruction

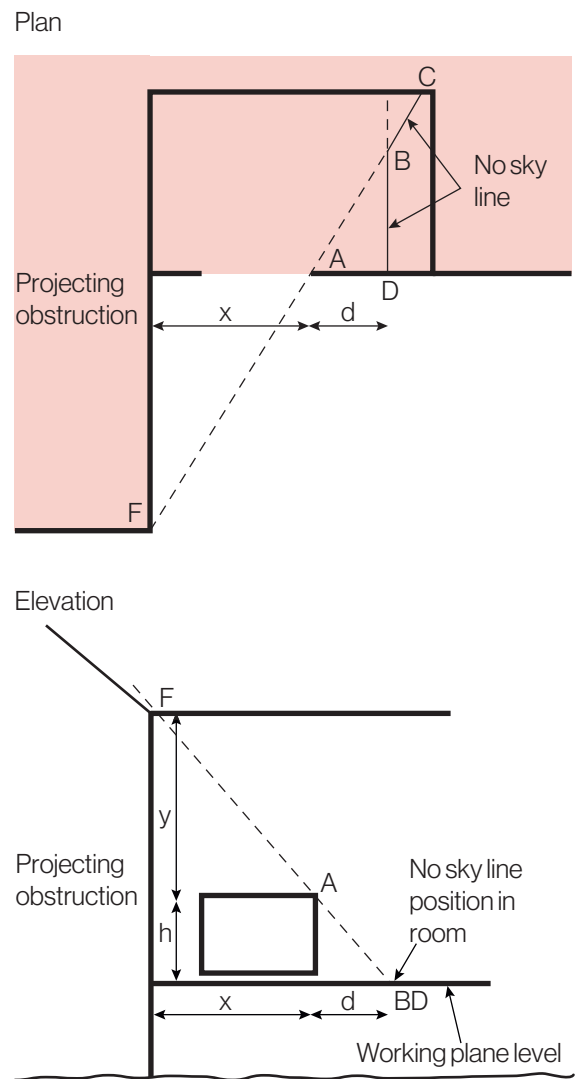

Figure D5: For a horizontal obstruction projecting from the window wall, the no sky line runs partly parallel to the obstruction and partly along a continuation of the line joining the end of the obstruction F and the side of the window A

D11 The analysis of Figures D5 and D6 assumes that the window wall is negligibly thin. If the window wall is thick then the no sky area is larger and part of the no sky line may be curved rather than straight. For example in Figure D5 the no sky line BD would instead curve westwards as it neared the window wall, finally touching it at point A. This only makes a significant difference within around four or five wall thicknesses of the window wall.

More complex situations

D12 These generally occur where there are a number of obstructions which, seen from the interior, appear to lie partly behind each other. A typical example is a row of detached or semi-detached houses with gaps in between (Figure D7). The no sky line PQRSTUUVWX is drawn on the room plan. It is a combination of curved and straight lines. In area QRSTU sky is visible above the gap BC; in area VWXY it is visible above the gap DE.

D13 In fact, in this particular case the no sky line is a relatively poor indicator of the daylit appearance of the room. This is because only a very small amount of skylight actually comes through the gaps BC and DE into the room. A better indicator of daylight distribution is the line PY which would be the no sky line if ABCDE were a continuous terrace. It is of course easier to construct than PQRSTUUVWX.

D14 Where there is more than one window, the final no sky line will surround those areas which cannot receive direct skylight from any of the windows. This can be arrived at by considering each window on its own at first, then combining them. In a room with windows on more than one side, it is often the case that all points on the working plane receive direct skylight through one window or another.

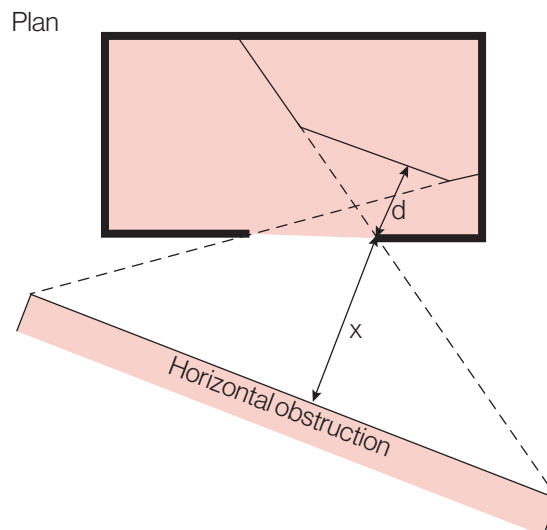

Figure D6: For a general horizontal obstruction, part of the no sky line runs parallel to the obstruction. The rest runs along the projected lines from the ends of the obstruction through the corners of the window.

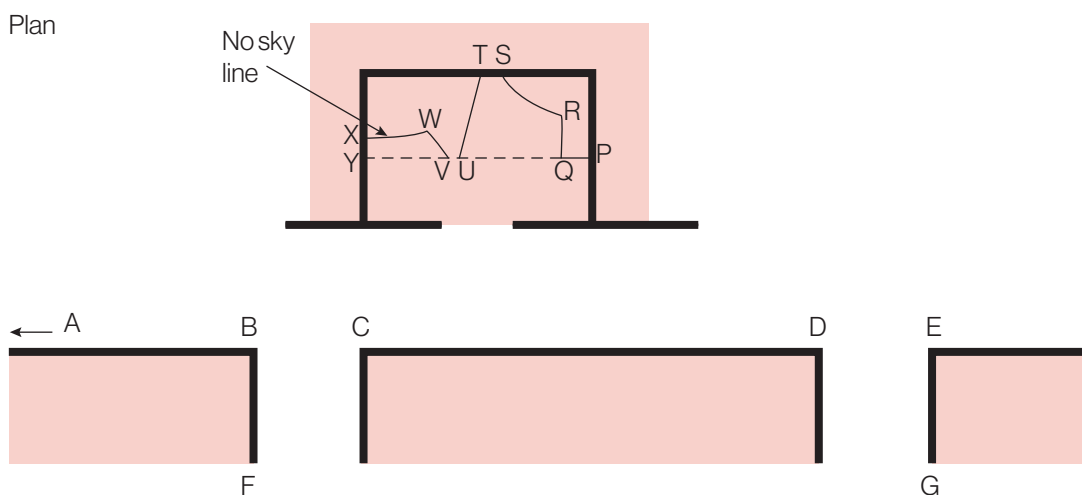

Figure D7: Complex no sky line from a set of obstructions

Appendix E: Rights to light

E1 The right to light is a legal right that one property may acquire over the land of another. If a building or wall is erected on this land which reduces the light in the obstructed property to below sufficient levels, then the right to light is infringed. The owner or tenant of the obstructed property may seek legal redress, for removal of the obstruction and/or damages. Recent case law has demonstrated how this can result in considerable expense, involving demolition of large parts of recently constructed buildings. It is prudent therefore to consider the question of rights of light at the design stage.

E2 A full explanation of rights of light is outside the scope of this BRE Report. Guidance on rights of light is given in a number of textbooks^[E1-E5] and by RICS^[E6-7]. This appendix describes the law in England and Wales as it currently stands; different legislation applies in Scotland and Ireland, and many countries do not have rights to light laws.

E3 A right to light can be acquired by a legal agreement, or under the terms of the Prescription Act of 1832 if the light has been enjoyed without interruption for at least 20 years. If the light is obstructed for more than a year then the right may be lost under the Prescription Act, but caution should be exercised as there may still be certain circumstances under which an action can be taken. Sometimes, if windows have received light over adjoining land for nearly 20 years, the owner of the adjoining land may register a Notice of Notional Obstruction under the 1959 Rights of Light Act. This is a way of preventing the windows from acquiring a right to light over the land when the 20 years has expired. A right to light can also be rescinded by a legal agreement, usually with compensation to the owner of the property whose light is lost.

E4 The right to light is for light from the sky alone; no right to sunlight exists, although there is a precedent for removal of obstructions to a greenhouse. Nor is there a right to a view. Also, the right is only to the amount of light that is 'sufficient for ordinary purposes' and does not compare directly with the recommendations in BS EN 17037^[E8] (see Appendix C).

E5 The accepted way of calculating the loss of light is to compute the sky factor at a series of points on the working plane. In dwellings, the working plane height is usually taken to be 0.85 m (two feet nine inches). The sky factor is the ratio of the illuminance directly received from a uniform sky at the point indoors, to the illuminance outdoors under an unobstructed hemisphere of this sky. No allowance is made for glass losses or light blocked by glazed bars and (usually) window frames; nor is reflected light included, either from interior surfaces or obstructions outside. Thus the sky factor is not the same as the CIE daylight factor (see Appendix C). The sky factor is often calculated using a Waldram diagram^[E9], but this is a different Waldram Diagram to Figure B1 in Appendix B, which should not be used for this purpose.

E6 The approach used in previous court cases^[E1-E3] has been to plot the 0.2% sky factor contour in the room, both before and after the new obstruction is erected. Figure E1 shows an example. The areas of the room which lie beyond these 0.2% contours 'before' and 'after' are then found. (Note that the 'before' condition should include any obstructions previously on the adjoining site). According to legal precedent, if more than half a room has a sky factor of less than 0.2%, then the room as a whole is inadequately lit. This is not a hard and fast rule, and

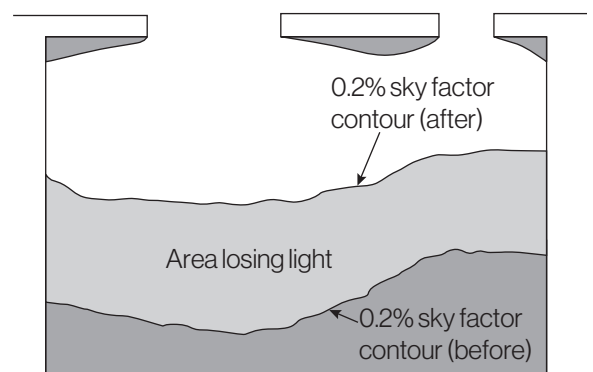

Figure E1: Plan of room showing movement of the 0.2% sky factor contour following erection of an obstruction

in one case a room was deemed inadequately lit even though slightly less than half of it had a sky factor of less than 0.2%. One important factor is whether the proposed new building is one of a number of possible future obstructions which might further reduce the light in the existing room.

E7 The area with a sky factor less than 0.2% will always be greater than the area of the room beyond the no sky line (Appendix D). Thus if more than half of the room is beyond the no sky line with the new development in place, it follows automatically that more than half the room will have a sky factor below 0.2%.

E8 As a general guide, currently if after construction of a proposed development more than half of a room in an existing building has a sky factor of less than 0.2%, and a right to light exists, then this right will probably be infringed. Developers should exercise extreme caution as the law in this area is very complex and they should seek expert advice. The risks of an injunction being granted are considerable, particularly if complaints from adjoining owners are ignored.

E9 There has been an active debate by experts in the field of rights to light regarding the legal measure of adequacy^[E10–E13]. This debate concerns the use of a non-uniform (CIE Overcast sky) in the calculation process, the 0.2% value for the criterion, and the use of the working plane at 0.85m.

References

- E1 Anstey J and Harris L. Anstey's rights of light. London, RICS, 2006.
- E2 Bickford Smith S and Francis A. Rights of light: the modern law. Bristol, Jordans, 2021.
- E3 Ellis P. Rights to Light. London, Estates Gazette, 1989.
- E4 Hannaford S, Stephens J and O'Hagan R. Rights to light. Coventry, RICS Books, 2008.
- E5 Redler A. Practical neighbour law handbook. London, RICS, 2006.
- E6 RICS. A clear impartial guide to Right to Light. London, RICS, 2008.
- E7 RICS. Rights of Light. London, RICS, 2016.
- E8 BSI. Daylight in buildings. BS EN 17037. London, BSI, 2018.
- E9 Hopkinson R G, Petherbridge P and Longmore J. Daylighting. London, Heinemann, 1966.
- E10 Defoe P S and Frame I. Was Waldram wrong? Structural Survey Journal, 2007, 25 (2): 98–116.
- E11 Defoe P S. Waldram was wrong! Structural Survey Journal, 2009, 27 (3): 186–199.
- E12 Pitts M. The grumble point is it still worth the candle? Structural Survey Journal, 2000, 18 (5): 255–258.
- E13 Chynoweth P. Progressing the rights to light debate part II: the grumble point revisited. Structural Survey Journal, 23 (4) 251–264, 2005.

Appendix F: Setting alternative target values for skylight and sunlight access

F1 Sections 2.1, 2.2, and 2.3 give numerical target values in assessing how much light from the sky is blocked by obstructing buildings. These values are purely advisory and different targets may be used based on the special requirements of the proposed development or its location. Such alternative targets may be generated from the layout dimensions of existing development, or they may be derived from considering the internal layout and daylighting needs of the proposed development itself.

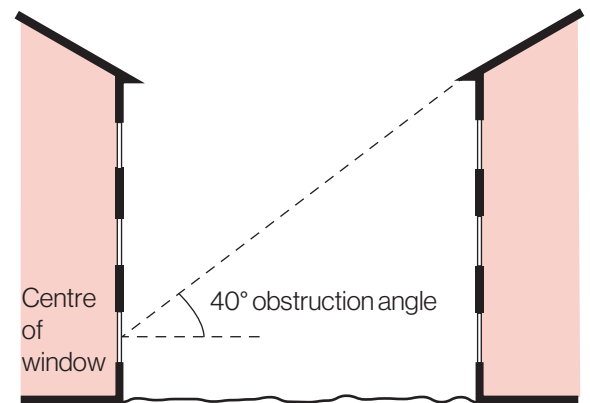

Figure F1: Hypothetical example of a narrow mews with a higher obstruction angle

F2 Sometimes there may be an extant planning permission for a site but the developer wants to change the design. In assessing the loss of light to existing windows nearby, a local authority may allow the vertical sky component (VSC) and annual probable sunlight hours (APSH) for the permitted scheme to be used as alternative benchmarks. However since the permitted scheme only exists on paper, it would be inappropriate for it to be treated in the same way as an existing building, and for the developer to set 0.80 times the values for the permitted scheme as benchmarks.

F3 Whatever the targets chosen for a particular development, it is important that they should be selfconsistent. Table F1 can be used to ensure this. First a limiting obstruction angle (for wide obstructions) is chosen from the first column. The second column expresses this as the ratio (spacing of obstruction)/(height above reference point). The third column gives the equivalent VSC at the reference point; this can be used to assess the skylight impact of taller, narrower obstructions. The remaining three columns give the corresponding quantities which can be used to assess the amount of skylight left to reach adjoining development land (Section 2.3). They are derived from the building-to-building angles in the first column, by using the method illustrated in Figure 12 of Section 2.3, which constructs an imaginary 'mirror image' building the other side of the boundary. Again all angles and heights are expressed relative to a reference point which would normally be at the level of the lowest window.

F4 Figure F1 illustrates a hypothetical example of a mews in a historic city centre, where the obstruction angle from ground floor window level might be close to 40°. This would correspond to a VSC of 18%, which could be used as a target value for ground floor windows in that street if new development is to match the existing layout. Windows at other levels would have a different obstruction angle and target VSC.

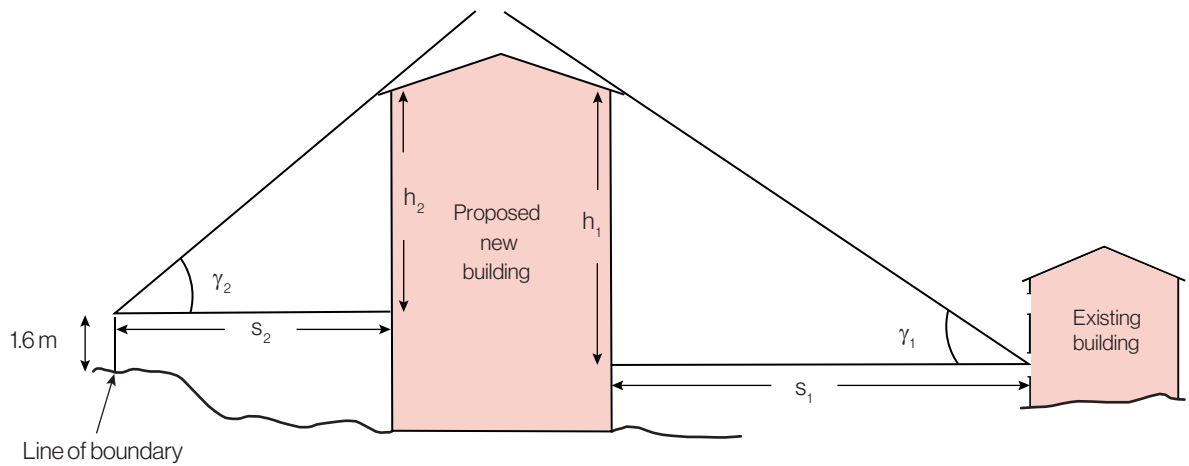

Figure F2: Angles, spacings and heights used in Table F1

Table F1 – Equivalent VSCs, spacing-to-height ratios and boundary parameters corresponding to particular obstruction angles between rows of buildings.					
Obstruction angle γ on building, degrees to horizontal	Equivalent spacing to height ratio (s_1/h_1)	Equivalent vertical sky component (VSC) (%)	Obstruction angle γ_1 at boundary (degrees to horizontal)	Spacing from boundary, divided by height (s_2/h_2)	Vertical sky component at boundary (%)
16	3.5	32	30	1.7	24
18	3.1	31	33	1.5	23
20	2.7	30	36	1.4	21
22	2.5	29	39	1.2	19
24	2.2	28	42	1.1	17
25	2.1	27	43	1.1	17
26	2.1	27	44	1.0	16
28	1.9	26	47	0.93	14
30	1.7	24	49	0.87	13
32	1.6	23	51	0.81	12
34	1.5	22	53	0.75	11
36	1.4	21	55	0.69	10
38	1.3	20	57	0.64	9
40	1.2	18	59	0.60	8
42	1.1	17	61	0.56	7
44	1.0	16	63	0.52	6
46	1.0	15	64	0.48	6
48	0.90	14	66	0.45	5
50	0.84	13	67	0.42	4

Note: Heights and angles are usually relative to a point at the centre of a window (see Figure F2)

F5 A similar approach may be adopted in cases where an existing building has windows that are unusually close to the site boundary and taking more than their fair share of light. Figure F3 shows an example, where side windows of an existing building are close to the boundary. To ensure that new development matches the height and proportions of existing buildings, the VSC, daylight distribution, and APSH targets for these windows could be set to those for a 'mirror-image' building of the same height and size, an equal distance away on the other side of the boundary.

F6. The 'mirror-image' approach needs to be applied sensibly and flexibly. For example where a long established dwelling has windows on or very close to the boundary, it would be inappropriate to block them up and remove all or nearly all their light. This may also infringe rights to light (see Appendix E).

F7 In assessing the loss of light to an existing building, the VSC is generally recommended as the appropriate parameter to use. This is because the VSC depends only on obstruction, and is therefore a measure of the daylight environment as a whole. The daylight factor and daylight illuminance (Appendix C) also depend on the room and window dimensions, the reflectances of interior surfaces and the type of glass, as well as the obstructions outside. These are appropriate measures to use in new buildings because most of these factors are within the developer's control.

F8 Use of the daylight factor or daylight illuminance for loss of light to existing buildings is not generally recommended. This tends to penalise well-daylit existing buildings, because they can take a much bigger and closer obstruction and remain above the minimum recommendations in BS EN 17037^[F1]. Because BS EN 17037 quotes a number of recommended values for different qualities of daylight provision, such a reduction in light would still constitute a loss of amenity to the room. Conversely if daylight factor and/or daylight illuminance values in an existing building were only just over the recommended minimum, even a tiny reduction in light from a new development would cause them to go below the minimum, restricting what could be built nearby.

F9 However, there are some situations where meeting set daylight factor or illuminance target values (Appendix C) with the new development in place could be appropriate as a criterion for loss of light:

- i. Where the existing building is one of a series of new buildings that are being built one after another, and each building has been designed as part of the larger group.
- ii. As a special case of (i), where the existing building is proposed but not built. A typical situation might be where the neighbouring building has received planning permission but not yet been constructed.
- iii. Where the developer of the new building also owns the existing nearby building and proposes to carry out improvements to the existing building (for example by increasing window sizes) to compensate for the loss of light. However, where there is a long-term occupier of the existing building it would be appropriate for there to be no reduction in daylight factor and/or daylight illuminance values, or at worst only a small reduction.
- iv. Where the developer of the new building also owns the existing nearby building and the affected rooms are either unoccupied or would be occupied by different people following construction of the new building.

F10 Notwithstanding the above guidance, the developer should still be aware of the rights to light of adjoining properties, as the higher levels of obstruction resulting from such a flexible approach may result in infringement of rights to light (see Appendix E).

Reference

F1 BSI. Daylight in buildings. BS EN 17037. London, BSI, 2018.

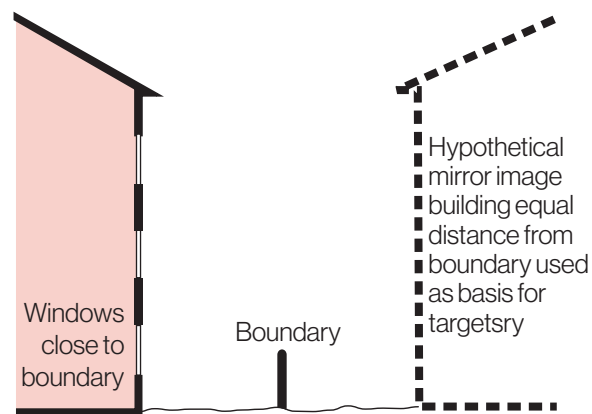

Figure F3: Use of a hypothetical mirror image building to set target daylight values

Appendix G: Trees and hedges

G1 Introduction

G1.1 Trees and hedges vary in their effects on skylight and sunlight. Most tree species will cast a partial shade^[G1,G2]; for deciduous trees this will vary with time of year. However very little light can penetrate dense belts of evergreen trees, and the shade they cause will be more like that of a building or wall.

G1.2 It is generally more difficult to calculate the effects of trees on daylight because of their irregular shapes and because some light will generally penetrate through the tree crown. Where the effect of a new building on existing buildings nearby is being analysed, it is usual to ignore the effect of existing trees. This is because daylight is at its scarcest and most valuable in winter when most trees will not be in leaf.



Figure G1. Use of a clinometer to measure tree height.

G2 Skylight in new dwellings obstructed by trees

G2.1 Sometimes, however, trees should be taken into account, for example where a new dwelling is proposed near to large existing trees. There may be concern that future occupants of the dwelling may want the trees to be cut down if they block too much skylight or sunlight.

G2.2 A way to assess this is to calculate the illuminances or daylight factors in the proposed rooms (Appendix C) with the trees in place. This will depend on the transparency of the trees; the proportion of light that passes through the tree crown.

G2.3 The calculation model should account for the obstruction to daylight caused by the trees. This needs to be done by modelling a representative shape of the trees. Often trees are irregularly shaped and simple modelling, using height and spread data and assuming a circular tree, will give inaccurate results. A special survey on site is generally required to produce the required data on the tree profile, using a clinometer or other device to measure tree height (Figure G1). Buildings and other solid objects should also be taken into account.

G2.4 The assessment should account for the transparency and reflectance of the trees, which can vary across the seasons.

G2.5 Table G1 contains data^[G3,G4] on the optical transparency of tree crowns for winter and summer.

Table G1 – Transparencies of tree crowns to solar radiation

Botanical name	Common name	Transparency (% radiation passing)	
		Full leaf	Bare branch
<i>Acer pseudoplatanus</i>	Sycamore	20	60
<i>Acer saccharinum</i>	Silver maple	15	55
<i>Aesculus hippocastanum</i>	Horse chestnut	20	55
<i>Betula pendula</i>	European birch	20	55
<i>Fagus sylvatica</i>	European beech	20	45*
<i>Fraxinus excelsior</i>	European ash	25	65
<i>Gleditsia</i>	Locust	30	80
<i>Quercus robur</i>	English oak	20	55*
<i>Tilia cordata</i>	Lime	10	55
<i>Ulmus</i>	Elm	15	65

* The beech, and some oaks, tend to retain dead leaves for much of the winter, reaching bare branch condition only briefly before new leaf growth in the spring. The transparency value for beech is an average winter value.

Notes

The data in Table G1 apply to individual tree crowns; multi-row belts or blocks may let virtually no radiation through when in leaf, and very little when in bare-branch condition. The values are averages from a range of sources, which show large differences for some of the values. The values must therefore be treated with caution, noting that in any case there will be considerable divergence in the transparencies of individual trees, especially in summer.

In cases of doubt, or for trees which are not included in table G1, the transparency may be estimated on site from the proportion of the crown that appears to be visible sky. This may require site visits in both winter and summer.

G2.6 Table G2 contains data on the reflectance of trees in summer and winter.

Table G2 – Reflectances of trees

	Reflectance (%)	
	Summer	Winter
Trees with dense light-coloured foliage in summer	40	10
Trees with open foliage	20	10
Evergreen conifers	10	10

G2.7 In order to assess interior daylighting two methods can be used in the British Standard *Daylight in Buildings*, BS EN 17037: illuminances through the year or daylight factor^[G5] (Appendix C). BS EN 17037 does not give guidance on trees. When using the former method, illuminances are assessed at calculation points for at least hourly intervals. The transparency and reflectances of the modelled trees therefore need to be varied to account for summer and winter; BRE Digest 350^[G6] gives times when trees are in leaf.

G2.8 If using the daylight factor method, the calculations should be repeated for summer and winter conditions and two sets of results shown. If BS EN 17037 recommended values of daylight factor over at least half of an assessment grid are exceeded in both summer and winter, then daylight would be considered adequate; and if the recommendations are not reached in both summer or winter then daylight would be considered inadequate. For a room where the recommendation is exceeded in winter, but not in summer, daylight provision year round is likely to be adequate, but it is clear that the trees are having some effect on daylight.

G3 Sunlight in new dwellings obstructed by trees

G3.1 To assess sunlight provision to new dwellings, BS EN 17037 recommends the calculation of hours of sunlight received on a single day, assuming clear skies; 21 March is the suggested date. This can be computed using the sunpath indicators (Figures A5 to A7), geometric equations, or specialist software. At this time of the year deciduous trees will not be in full leaf and therefore some sun will be expected to penetrate. However, it would be impossible to accurately simulate how the fragmented obstruction of a tree would obstruct direct sunlight to a point at a particular time.

G3.2 It is therefore recommended that where trees may affect sunlight provision, the calculations should first be carried out with deciduous trees as opaque objects (this should be based on a detailed site survey of tree profile). The calculations could then be repeated without deciduous trees entirely. This gives the range of potential sunlight hours. Buildings and other solid objects should always be included. Evergreen trees where no light can penetrate all year round should also always be included as solid.

G3.3 According to BS EN 17037 a room in a dwelling should receive a minimum 1.5 hours on the assessment date. The medium recommendation is three hours, and the high recommendation four hours.

G3.4 If the minimum recommendation is met with opaque trees then sunlight would be adequate. If the minimum recommendation is not reached with either opaque trees or no trees then sunlight would be considered inadequate. For a room where the recommendation is exceeded without trees, but not with opaque trees, sunlight provision may be adequate, but the trees will have some effect on the sunlight received.

G4 Sunlight in gardens with trees

G4.1 In assessing the impact of buildings on sunlight in gardens (see section 3.3), trees and shrubs are not normally included in the calculation unless a dense belt or group of evergreens is specifically planned as a windbreak or for privacy purposes. This is partly because the dappled shade of a tree is more pleasant than the deep shadow of a building (this applies especially to deciduous trees).

G4.2 People vary in their preferences, and some like to have a shady, secluded garden. However, most people would be satisfied with some areas of partial shade under trees, and other parts of the garden or amenity area in full sun. If the whole of the garden is shaded by trees for a lengthy period of time in summer, the garden is probably too shady.

G5 Effect of hedges

G5.1 High hedges may cause loss of sunlight and skylight to neighbouring gardens and houses. Under the Anti-Social Behaviour Act 2003, a local authority may require a hedge to be pruned if it is causing a nuisance, which can include if it is blocking too much sunlight or skylight.

G5.2 A separate document *Hedge height and light loss*^[G7] provides a way of calculating the height of a hedge that is likely to cause significant loss of light to a garden or house nearby. This method could be used by a hedge owner, or by an affected neighbour, to find out if a hedge is likely to block too much light to the neighbour's house or garden. The advice in the document is not mandatory, and is only one of the factors a local authority will need to take into account.

G5.3 In the Anti-Social Behaviour Act, 'high hedge' means 'so much of a barrier to light or access as (a) is formed wholly or predominantly by a line of two or more evergreens; and (b) rises to a height of more than two metres above ground level'.

Consequently, these guidelines apply to evergreen hedges. They have not been designed to be applied to individual trees, groups of trees or woodlands.

G5.4 *Hedge height and light loss*^[G7] introduces the concept of 'action hedge height' above which a hedge is likely to block too much light. It then gives a procedure to calculate this height both for a garden, and for windows to main rooms in a dwelling. The minimum action hedge height is 2 m.

G5.5 The procedure is intended to be simple enough for householders to use. It involves multiplying the distance from a window to the hedge, or the depth of the garden, by a factor; for gardens this factor depends on hedge orientation. Corrections can be made for site slope or where the hedge is set back from a garden boundary.

G5.6 For a small number of complex situations (e.g. where there is a building behind the hedge), or where the hedge is an irregular shape or has gaps in it, *Hedge height and light loss* suggests that the guidelines in this guide be used to assess loss of skylight and sunlight to windows. For this purpose, the skylight blocked by the hedge is likely to be significant if the VSC at the centre of the window is both less than 27% and less than 0.8 times its value without the hedge in place (see Section 2.2). The loss of sunlight is likely to be significant if the APSH, at the centre of a main living room window, are less than 25% and less than 0.80 times the value without the hedge (see Section 3.2).

References

- G1 BRE. Climate and site development: Part 1: General climate of the UK; Part 2: Influence of microclimate; Part 3: Improving microclimate through design'. BRE DG 350. Bracknell, IHS BRE Press, 1983.
- G2 Littlefair P.J. et al. Environmental site layout planning: solar access, passive cooling and microclimate in urban areas. BRE BR 380, Bracknell, IHS BRE Press, 2000.
- G3 Yates D. and McKennan G.T. Solar architecture and light attenuation by trees: conflict or compromise? *Arboricultural Journal*, 1989, 13: 7-16.
- G4 Wilkinson D.M., Yates D. and McKennan G.T. Light attenuation characteristics of seven common British trees. *Arboricultural Journal*, 1991, 15: 37-44.
- G5 BSI. Daylight in buildings. BS EN 17037. London, BSI, 2019.
- G6 BRE. Climate and site development: Part 1: General climate of the UK; Part 2: Influence of microclimate; Part 3: Improving microclimate through design. BRE DG 350. Bracknell, IHS BRE Press, 1983.
- G7 DCLG. Hedge height and light loss. London, DCLG, 2004.

Appendix H: Environmental impact assessment

H1 The guidelines in this book may be used as the basis for environmental impact assessment, where the skylight and sunlight impact of a new development on its surroundings are taken into account.

H2 Where a new development affects a number of existing buildings or open spaces, the clearest approach is usually to assess the impact on each one separately. It is also clearer to assess skylight and sunlight impacts separately.

H3 Adverse impacts occur when there is a significant decrease in the amount of skylight and sunlight reaching an existing building where it is required, or in the amount of sunlight reaching an open space.

H4 The assessment of impact will depend on a combination of factors, and there is no simple rule of thumb that can be applied.

H5 Where the loss of skylight or sunlight fully meets the guidelines in this document, the impact is assessed as negligible or minor adverse. Where the loss of light is well within the guidelines, or only a small number of windows or limited area of open space lose light (within the guidelines), a classification of negligible impact is more appropriate. Where the loss of light is only just within the guidelines, and a larger number of windows or open space area are affected, a minor adverse impact would be more appropriate, especially if there is a particularly strong requirement for daylight and sunlight in the affected building or open space.

H6 Where the loss of skylight or sunlight does not meet the guidelines in this document, the impact is assessed as minor, moderate or major adverse. Factors tending towards a minor adverse impact include:

- only a small number of windows or limited area of open space are affected
- the loss of light is only marginally outside the guidelines
- an affected room has other sources of skylight or sunlight
- the affected building or open space only has a low level requirement for skylight or sunlight
- there are particular reasons why an alternative, less stringent, guideline should be applied, for example an overhang above the window or a window standing unusually close to the boundary.

H7 Factors tending towards a major adverse impact include:

- a large number of windows or large area of open space are affected
- the loss of light is substantially outside the guidelines
- all the windows in a particular property are affected
- the affected indoor or outdoor spaces have a particularly strong requirement for skylight or sunlight, e.g. a living room in a dwelling or a children's playground.

H8 Beneficial impacts occur when there is a significant increase in the amount of skylight and sunlight reaching an existing building where it is required, or in the amount of sunlight reaching an open space. Beneficial impacts should be worked out using the same principles as adverse impacts. Thus a tiny increase in light would be classified as a negligible impact, not a minor beneficial impact.

H9 An adverse impact on one property cannot be balanced against negligible or beneficial impacts on other properties. In these situations it is more appropriate to quote a range of impacts.

H10 The provision of new dwellings, or commercial or industrial buildings, or private gardens that meet the skylight or sunlight guidance in this document should not be classified as a beneficial daylight or sunlight impact on the local environment. However, the provision of community buildings or public open spaces with good skylight and/or sunlight could be classed as a beneficial impact.



**For more information on
BRE:**

+44 (0)333 321 88 11
enquiries@bregroup.com
www.bregroup.com